



LB-60180-NF Broadband Horn Antenna 6-18GHz 10dB Gain N Type Female

Broadband Horn Antenna Operating From 6GHz to 18GHz With a Nominal 10dB Gain With N Type Female Connector

Product Information

SKU	LB-60180-NF
-----	-------------

Description

Broadband horn antenna LB-60180-NF, operating from 6 to 18GHz with a nominal 10dB gain and low VSWR 1.5:1 with N Type Female output connector. The model LB-60180-NF has uniform gain through its frequency span, providing efficient performance characteristics and directionality. It can handle 150W continuously and 300W peak power. Constructed of lightweight corrosion-resistant aluminum, the antenna will provide years of trouble-free indoor and outdoor service. This broadband horn antenna is linearly polarized and ideally suited for EMI testing, direction finding, surveillance, antenna gain and pattern measurements and other applications.

Technical Specification

Electrical Specification		Interface	
Frequency, Min (GHz)	6	Output Type	Coaxial
Frequency, Max (GHz)	18	Connector	N Type
Gain, Typ (dBi)	10	Connector Gender	Female
Polarization	Linear	Mechanical Specification	
3dB Beamwidth, E-Plane, Min (Deg.)	21	Body Material	Al
3dB Beamwidth, E-Plane, Max (Deg.)	67	Finish	Nickel Plated and Passivation, Gray Paint
3dB Beamwidth, H-Plane, Min (Deg.)	22	Size, W (mm)	55
3dB Beamwidth, H-Plane, Max (Deg.)	64	Size, H (mm)	55.1
Cross Pol. Isolation, Typ (dB)	40	Size, L (mm)	109
VSWR, Typ	1.5:1	Weight, (kg)	0.23
Impedance, (Ohm)	50		
Power Handling, CW, (W)	150		
Power Handling, Peak, (W)	3000		

Additional Information

Application	General Purpose Indoor & Outdoor, Fixed	Solution for	Gain Reference Antenna Measurement Reflector Feed Far-field Measurement System Intergration
-------------	---	--------------	---

Outline Drawing

N-Female Output (P/N: LB-60180-NF)

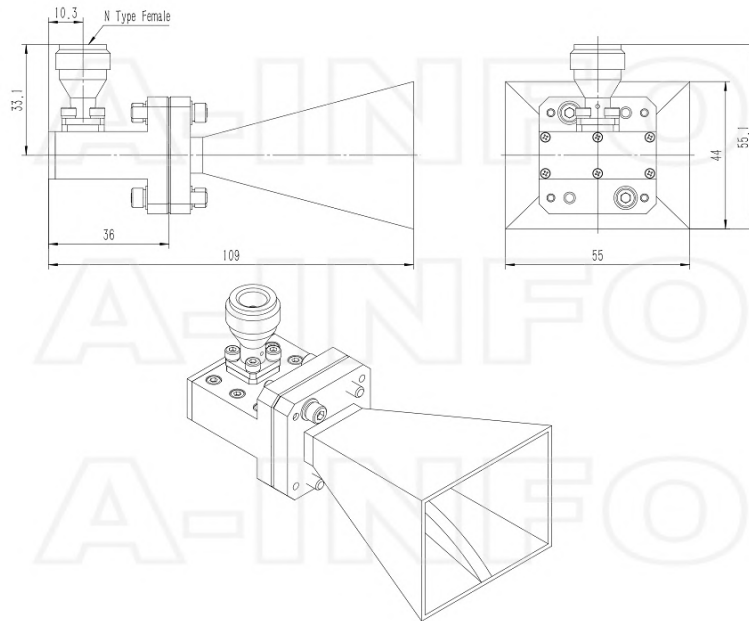

N-Female Output with Round Mounting Bracket (Option, P/N: LB-65180-10-C-MB)

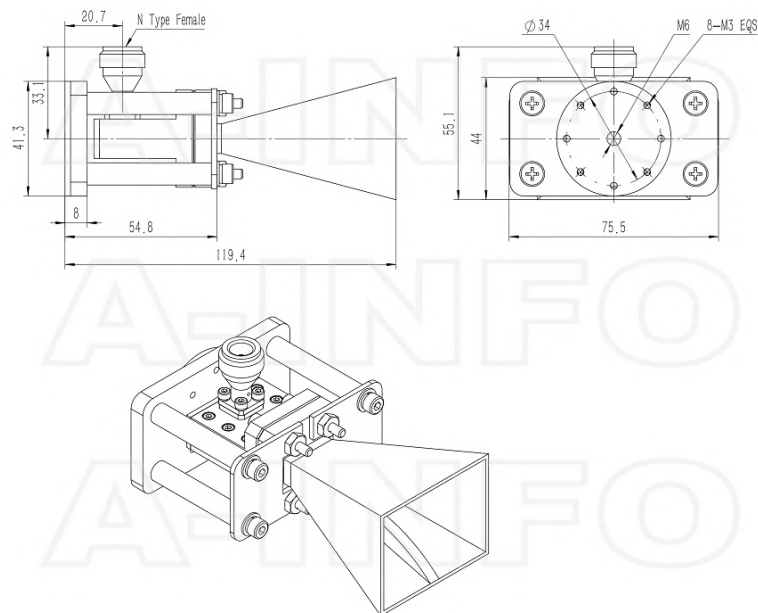

N-Female Output with L Type Mounting Bracket (Option, P/N: LB-65180-10-C-MBL)

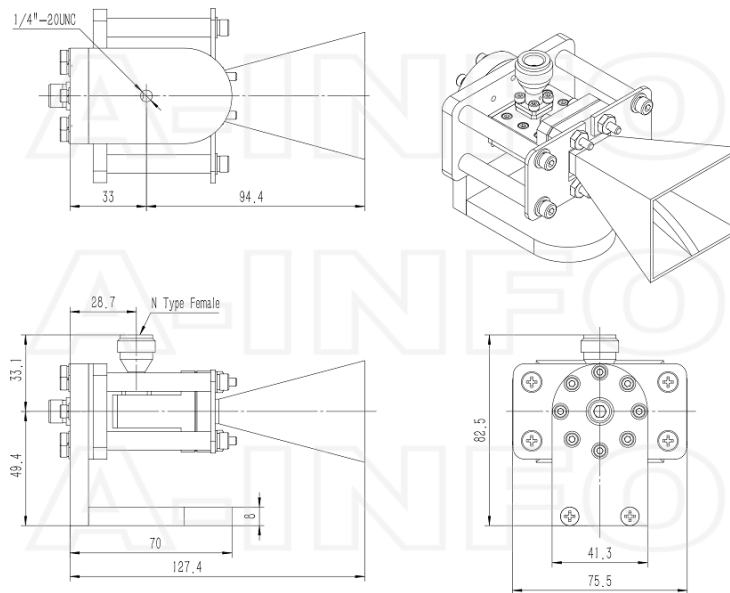

Typical Test Results

Gain

1m/3m

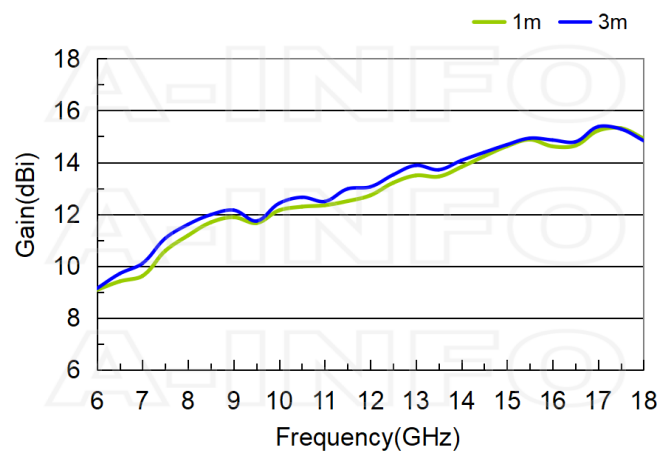

5m

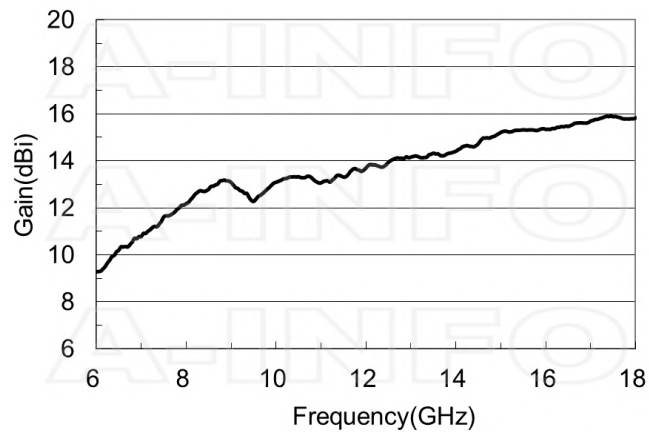

Antenna Factor

1m/3m

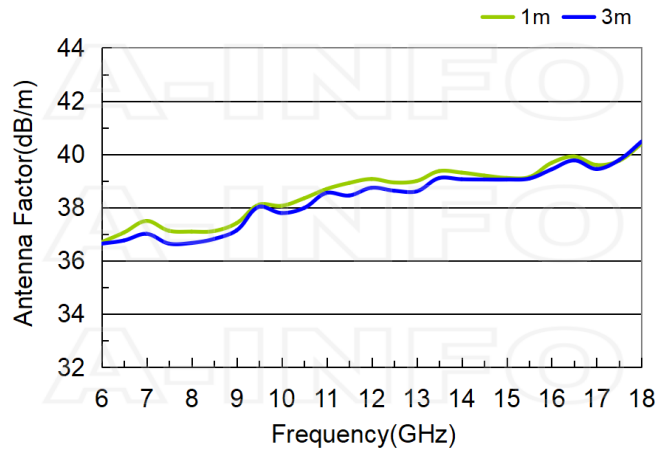

5m

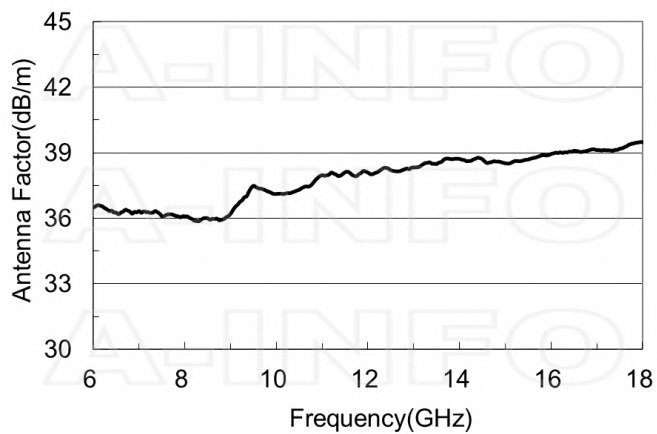

Antenna Factor (Table)

1m/3m

Frequency(GHz)	1m		3m	
	Gain(dBi)	AF(dB/m)	Gain(dBi)	AF(dB/m)
6.0	9.08	36.70	9.13	36.64
7.0	9.62	37.50	10.10	37.01
8.0	11.18	37.09	11.60	36.67
9.0	11.88	37.41	12.15	37.14
10.0	12.15	38.06	12.42	37.79
11.0	12.34	38.69	12.49	38.55
12.0	12.72	39.07	13.05	38.74
13.0	13.49	39.00	13.88	38.61
14.0	13.82	39.31	14.07	39.06
15.0	14.62	39.11	14.68	39.05
16.0	14.62	39.68	14.86	39.43
17.0	15.22	39.60	15.37	39.44
18.0	14.92	40.40	14.83	40.48

5m

Frequency(GHz)	Gain(dBi)	Antenna Factor(dB/m)
6.0	9.28	36.49
7.0	10.78	36.33
8.0	12.18	36.09
9.0	13.08	36.21
10.0	13.09	37.12
11.0	13.06	37.98
12.0	13.70	38.10
13.0	14.16	38.33
14.0	14.41	38.72
15.0	15.21	38.52
16.0	15.34	38.95
17.0	15.70	39.12
18.0	15.83	39.48

Field Strength

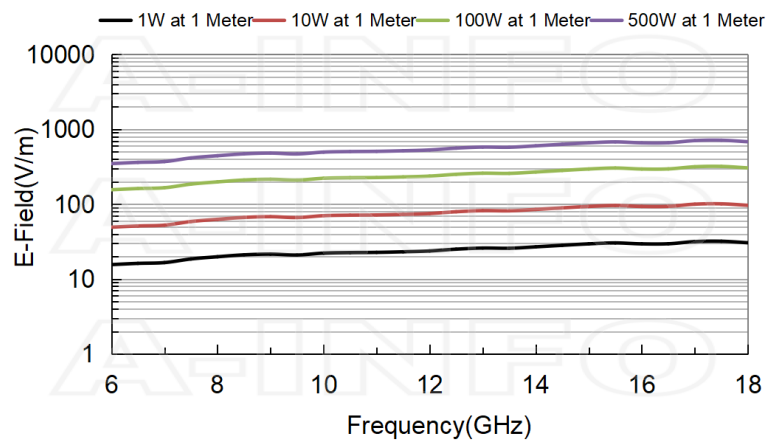

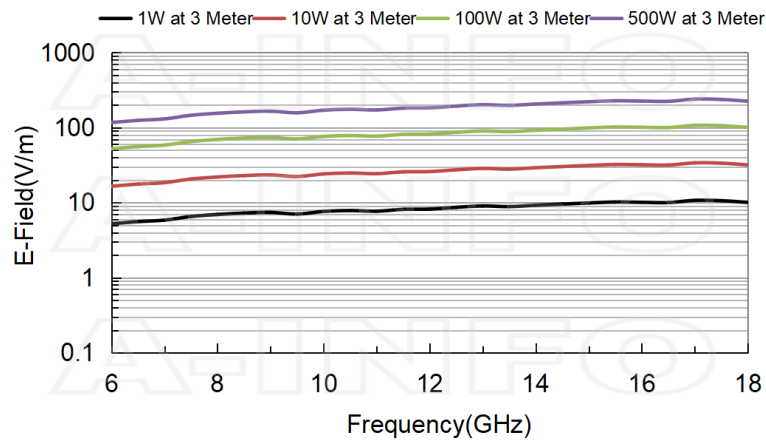

Cross Polarization Isolation

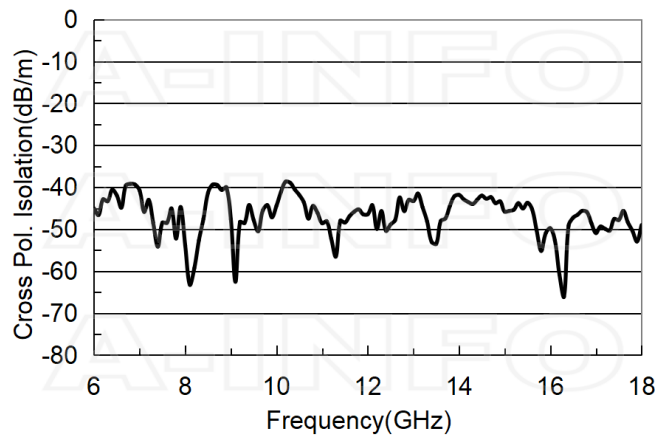

VSWR

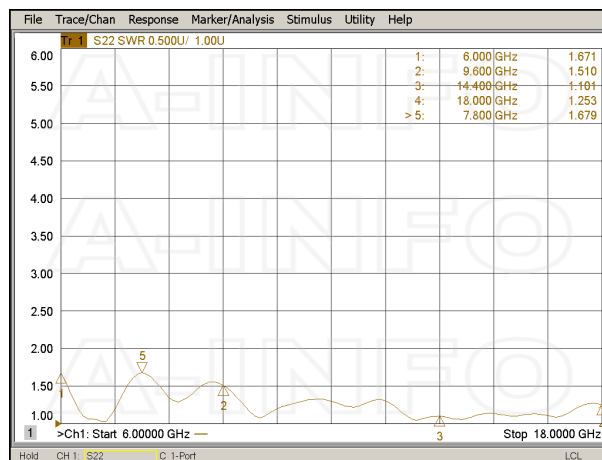

Pattern

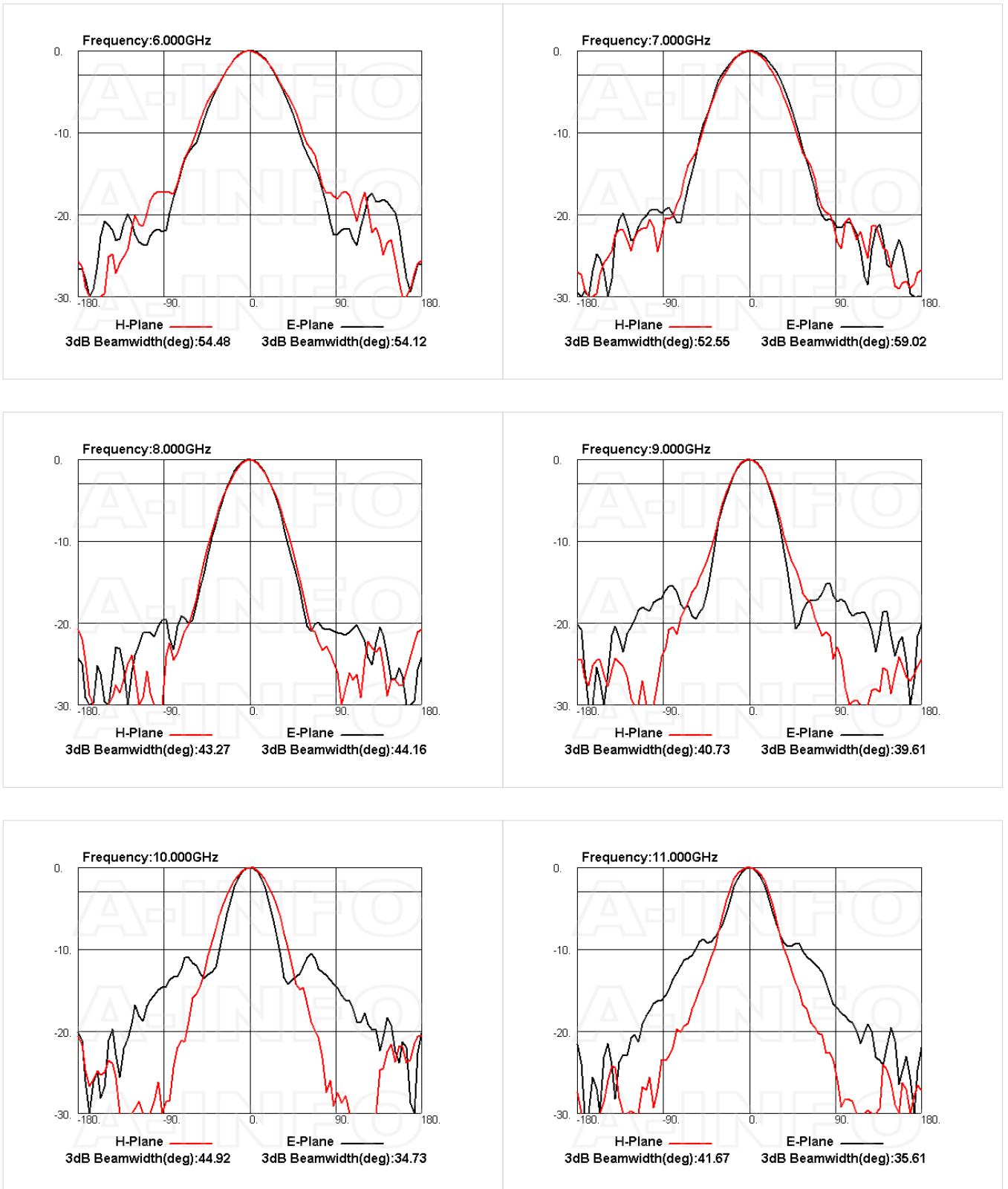

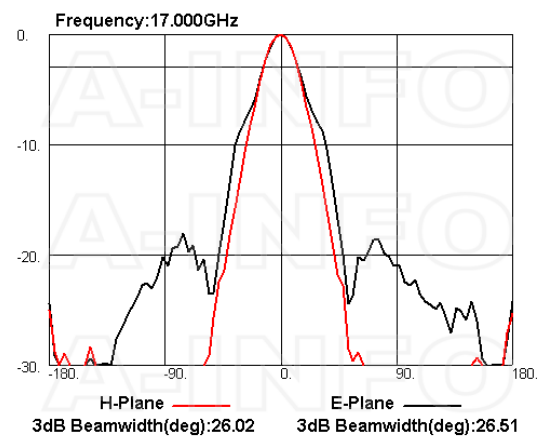
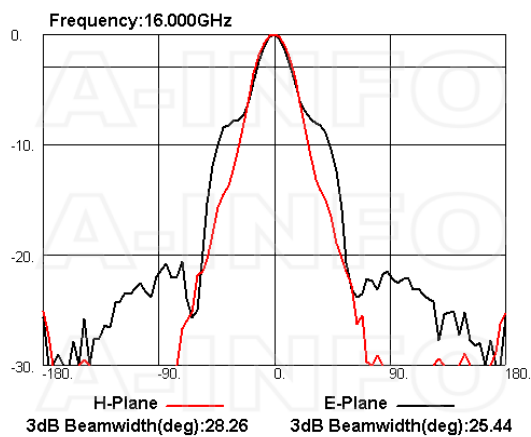
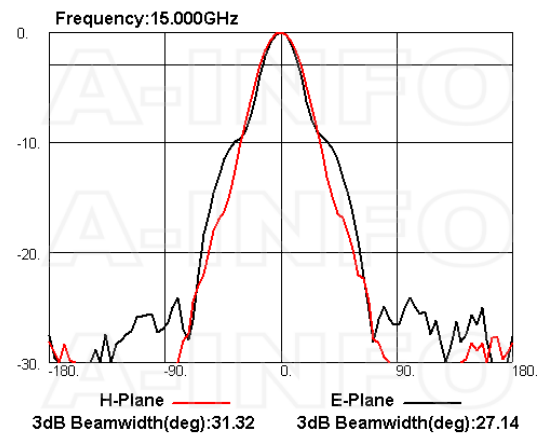
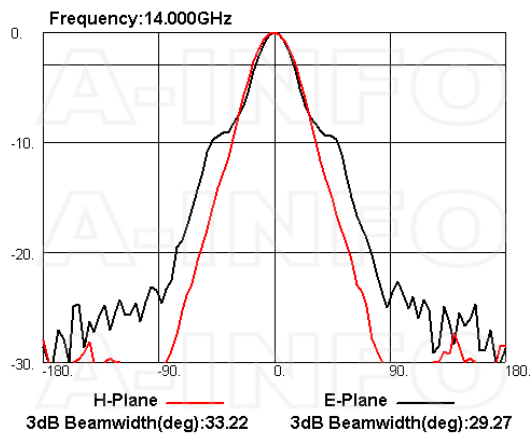
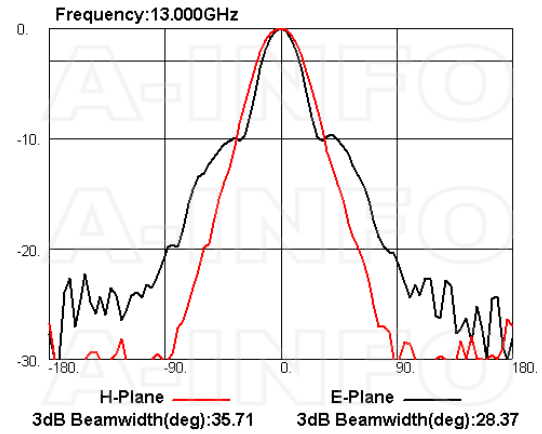
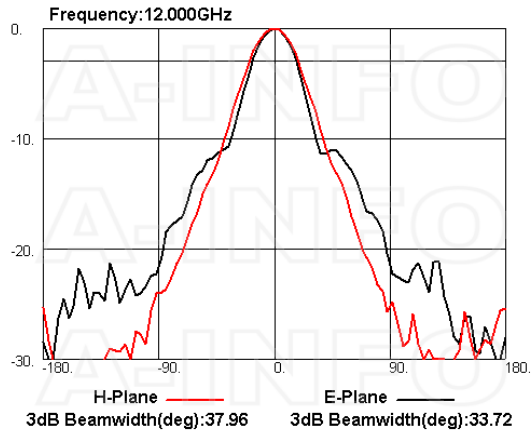

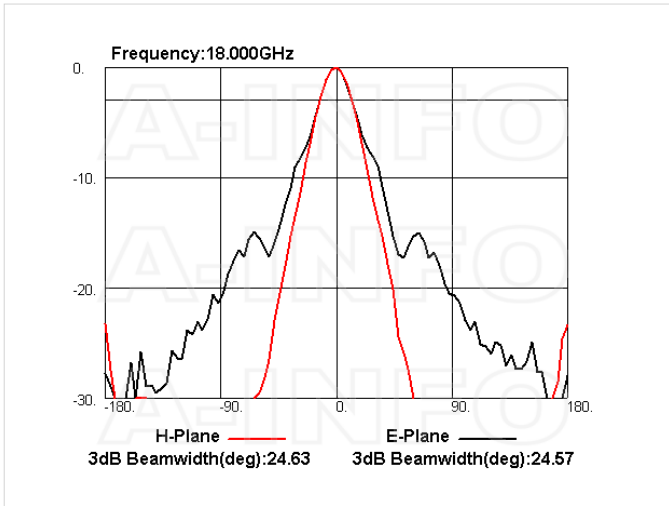

Related Products



LB-65180-10-C-MB Round Type Mounting Bracket



LB-65180-10-C-MBL L type mounting bracket



Tripod_15Kg Al Alloy Tripod



3033HL Wooden Tripod



3033QM Wooden Tripod Metalfree



Carrying Case_LB-60180 Al Alloy Carrying Case



NM-NM-A050-500 Flexible Cable Assembly 500mm DC- 18GHz N Male to N Male



NM-NM-A050-1000 Flexible Cable Assembly 1000mm DC- 18GHz N Male to N Male



NM-NM-A050-1500 Flexible Cable Assembly 1500mm DC- 18GHz N Male to N Male



NM-NM-A050-2000 Flexible Cable Assembly 2000mm DC- 18GHz N Male to N Male



NM-NM-A050-3000 Flexible Cable Assembly 3000mm DC- 18GHz N Male to N Male



NM-NM-A050-5000 Flexible Cable Assembly 5000mm DC- 18GHz N Male to N Male



NM-NM-A050-10000 Flexible Cable Assembly 10000mm DC-18GHz N Male to N Male



NM-NM-A050-20000 Flexible Cable Assembly 20000mm DC-18GHz N Male to N Male



NM-NM-A100-500 Flexible Cable Assembly 500mm DC-18GHz N Male to N Male



NM-NM-A100-1000 Flexible Cable Assembly 1000mm DC-18GHz N Male to N Male



NM-NM-A100-1500 Flexible Cable Assembly 1500mm DC-18GHz N Male to N Male



NM-NM-A100-2000 Flexible Cable Assembly 2000mm DC-18GHz N Male to N Male



NM-NM-A100-3000 Flexible Cable Assembly 3000mm DC-18GHz N Male to N Male



NM-NM-A100-5000 Flexible Cable Assembly 5000mm DC-18GHz N Male to N Male



NM-NM-A100-10000 Flexible Cable Assembly 10000mm DC-18GHz N Male to N Male



NM-NM-A100-20000 Flexible Cable Assembly 20000mm DC-18GHz N Male to N Male

Similar Products



LB-20180-SF Broadband Horn Antenna 2-18GHz 12dB Gain SMA Female



LB-20180-SFP Broadband Horn Antenna 2-18GHz 12dB Gain SMA Female



LB-20180-SFSPO Broadband Horn Antenna 2-18GHz 12dB Gain SMA Female



LB-20180-NF Broadband Horn Antenna 2-18GHz 12dB Gain N Type Female



LB-20180-NFP Broadband Horn Antenna 2-18GHz 12dB Gain N Type Female



LB-20180-NFSPO Broadband Horn Antenna 2-18GHz 12dB Gain N Type Female



LB-20180-NFSPS Broadband Horn Antenna 2-18GHz 12dB Gain N Type Female



LB-60180-NFSPO Broadband Horn Antenna 6-18GHz 10dB Gain N Type Female



LB-60180-SF Broadband Horn Antenna 6-18GHz 10dB Gain SMA Female



LB-60180-SFSPO Broadband Horn Antenna 6-18GHz 10dB Gain SMA Female



LB-60180-HNF Broadband Horn Antenna 6-18GHz 10dB Gain High Power N Type Female

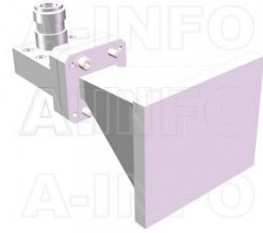

LB-60180-HNFSPS Broadband Horn Antenna 6-18GHz 10dB Gain High Power N Type Female



LB-80180-SF Broadband Horn Antenna 8-18GHz 10dB Gain SMA Female

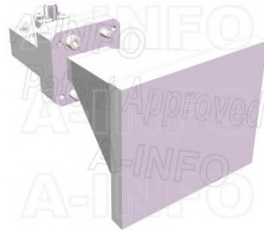

LB-80180-SFSPO Broadband Horn Antenna 8-18GHz 10dB Gain SMA Female



LB-80180-NF Broadband Horn Antenna 8-18GHz 10dB Gain N Type Female



LB-80180-NFSPO Broadband Horn Antenna 8-18GHz 10dB Gain N Type Female



LB-80180-HNF Broadband Horn Antenna 8-18GHz 10dB Gain High Power N Type Female

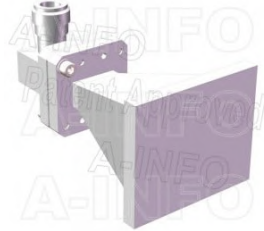

LB-80180-HNFSPS Broadband Horn Antenna 8-18GHz 10dB Gain High Power N Type Female



LB-60670-1.85F Broadband Horn Antenna 6-67GHz 13dB Gain 1.85mm Female



LB-60670-1.85FSPS Broadband Horn Antenna 6-67GHz 13dB Gain 1.85mm Female



LB-SJ-40400-KF Broadband Dual Polarization Horn Antenna
4-40GHz 12dB Gain 2.92mm Female



LB-SJ-40400-KFSPO Broadband Dual Polarization Horn Antenna
4-40GHz 12dB Gain 2.92mm Female



LB-SJ-40400-2.4F Broadband Dual Polarization Horn Antenna
4-40GHz 12dB Gain 2.4mm Female



LB-SJ-40400-2.4FSPO Broadband Dual Polarization Horn Antenna
4-40GHz 12dB Gain 2.4mm Female



LB-SJ-50500-2.4F Broadband Dual Polarization Horn Antenna
5-50GHz 12dB Gain 2.4mm Female



LB-SJ-50500-1.85F Broadband Dual Polarization Horn Antenna
5-50GHz 12dB Gain 1.85mm Female

About this Datasheet

<ul style="list-style-type: none"> ● Product Information Product Link: https://www.ainfoinc.com/lb-60180-nf-broadband-horn-antenna-6-18-ghz-10db-gain-n-type-female Data subject to change without notice. © A-INFO INC. 2024. All Rights Reserved 	<ul style="list-style-type: none"> ● Contact Us Address: 60 Tesla, Irvine, CA 92618, USA Website: www.ainfoinc.com Email: sales@ainfoinc.com 	<ul style="list-style-type: none"> ● Phone & Fax Phone: +1-949-639-9688 +1-949-639-9608 Fax: +1-949-639-9670
---	--	---