

LB-7180-NF Broadband Horn Antenna 0.7-18.0 GHz 12dB Gain N Type Female

Broadband Horn Antenna Operating From 0.7 GHz to 18.0 GHz With a Nominal 12 dB Gain With N Type Female Connector

Product Information

SKU	LB-7180-NF
-----	------------

Description

Broadband horn antenna LB-7180-NF, operating from 0.7 to 18 GHz with a nominal 12dB gain and low VSWR 2.0:1 with N Type Female output connector. The model LB-7180-NF has uniform gain through its frequency span, providing efficient performance characteristics and directionality. It can handle 300 W continuously and 500 W peak power. Constructed of lightweight corrosion-resistant aluminum, the antenna will provide years of trouble-free indoor and outdoor service. This broadband horn antenna is linearly polarized and ideally suited for EMI testing, direction finding, surveillance, antenna gain and pattern measurements and other applications.

Technical Specification

Electrical Specification		Interface	
Frequency, Min (GHz)	0.7	Output Type	Coaxial
Frequency, Max (GHz)	18	Connector	N Type
Gain, Typ (dBi)	12	Connector Gender	Female
Polarization	Linear	Mechanical Specification	
3dB Beamwidth, E-Plane, Min (Deg.)	10	Body Material	Al
3dB Beamwidth, E-Plane, Max (Deg.)	155	Finish	Chemical Conversion Coating
3dB Beamwidth, H-Plane, Min (Deg.)	9	Size, W (mm)	244
3dB Beamwidth, H-Plane, Max (Deg.)	95	Size, H (mm)	160.5
Cross Pol. Isolation, Typ (dB)	25	Size, L (mm)	228
VSWR, Typ	2.0:1	Weight, (kg)	1.5
Impedance, (Ohm)	50		
Power Handling, CW, (W)	300		
Power Handling, Peak, (W)	500		

Additional Information

Application	General Purpose Indoor & Outdoor, Fixed	Solution for	Gain Reference Antenna Measurement Reflector Feed Far-field Measurement System Intergration
-------------	---	--------------	---

Outline Drawing

N-Female Output (P/N: LB-7180-NF)

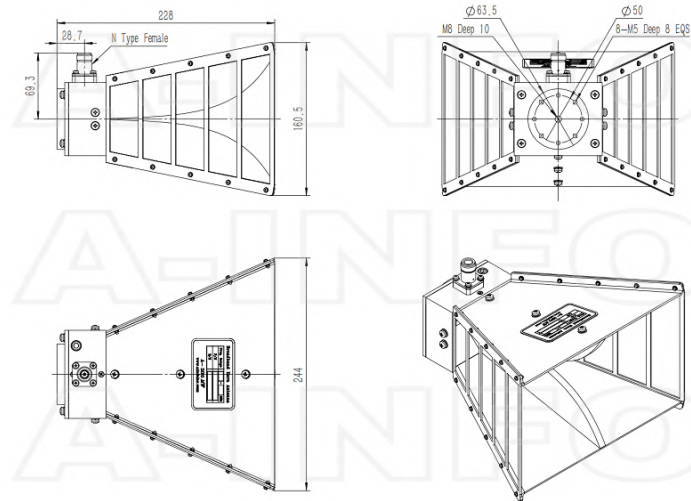

N-Female Output with L Type Mounting Bracket (Option, P/N: LB-10180-L)

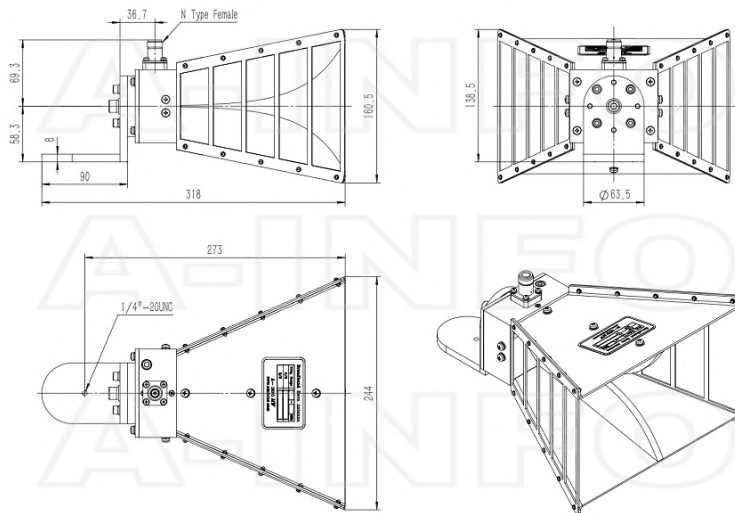

Typical Test Results

Gain

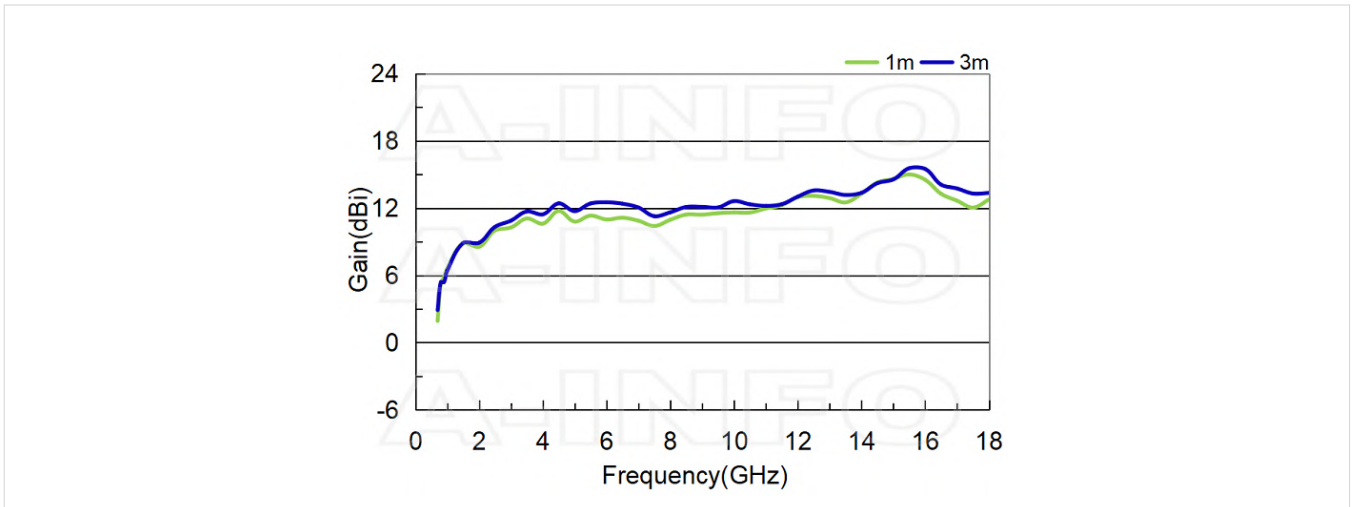

Antenna Factor

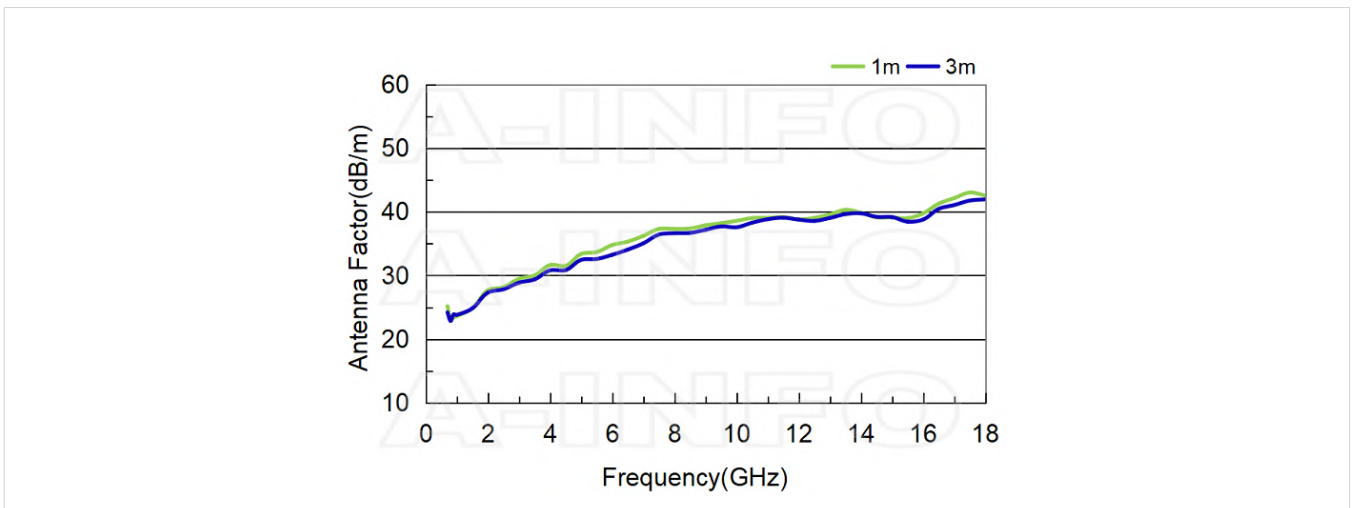

Antenna Factor (Table)

Frequency(GHz)	1m		3m	
	Gain(dBi)	AF(dB/m)	Gain(dBi)	AF(dB/m)
0.7	1.93	25.18	2.90	24.21
0.8	5.25	23.02	5.39	22.88
0.9	5.83	23.46	5.40	23.89
1.0	6.59	23.62	6.40	23.81
2.0	8.54	27.69	8.90	27.33
3.0	10.27	29.48	10.88	28.88
4.0	10.61	31.64	11.44	30.81
5.0	10.79	33.40	11.73	32.46
6.0	10.98	34.79	12.51	33.26
7.0	10.87	36.24	12.05	35.06
8.0	10.95	37.32	11.62	36.65
9.0	11.41	37.88	12.11	37.19
10.0	11.61	38.60	12.62	37.59
12.0	12.97	38.82	13.02	38.78
14.0	13.28	39.85	13.36	39.77
16.0	14.51	39.78	15.48	38.81
18.0	12.76	42.55	13.35	41.97

Field Strength

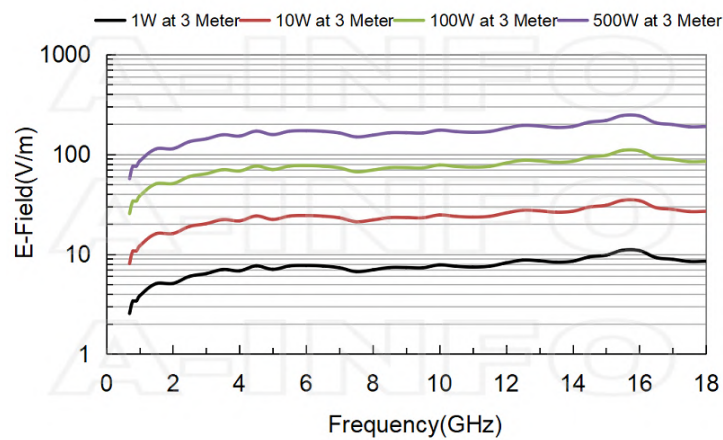
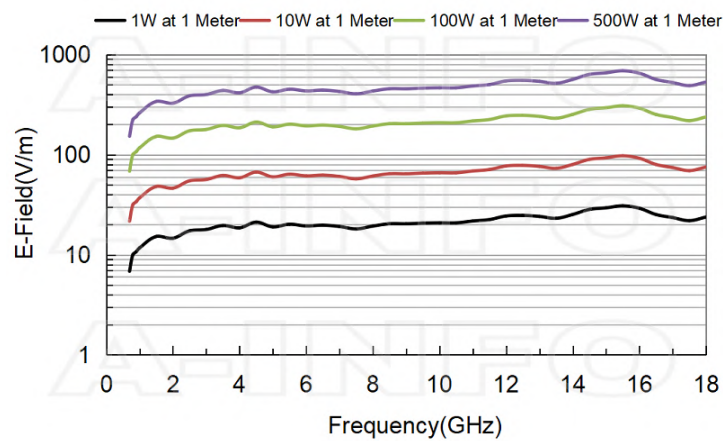

Cross Polarization Isolation

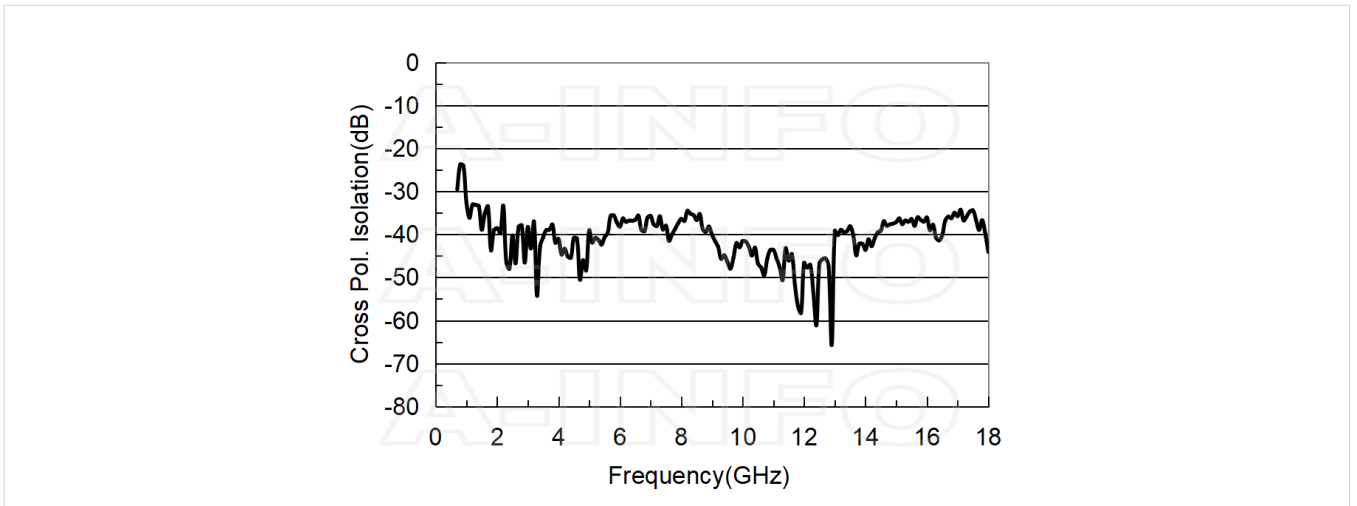

VSWR

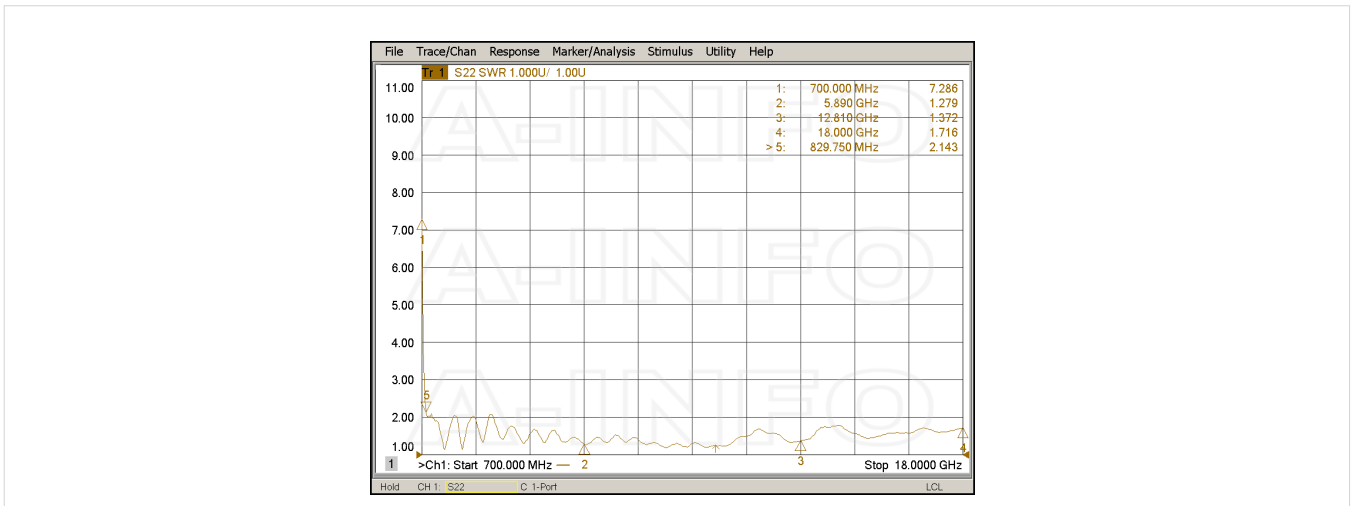

Beamwidth

3dB Beamwidth

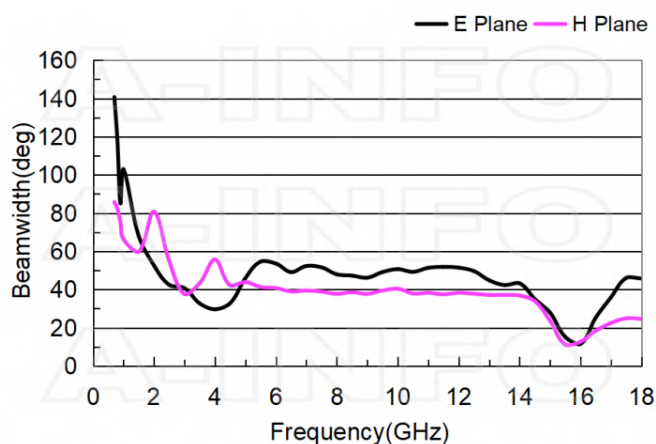

10dB Beamwidth

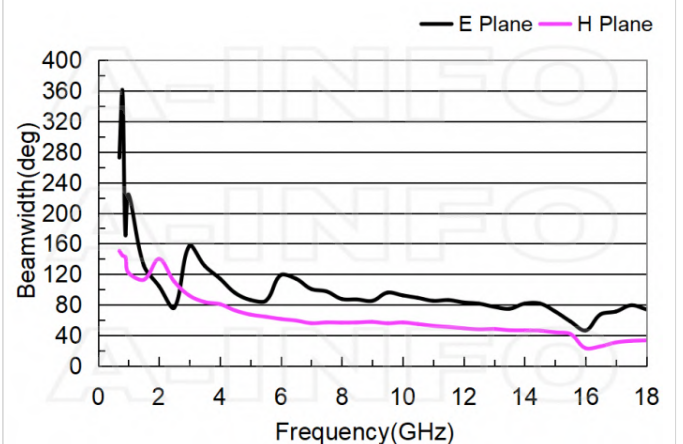

Pattern

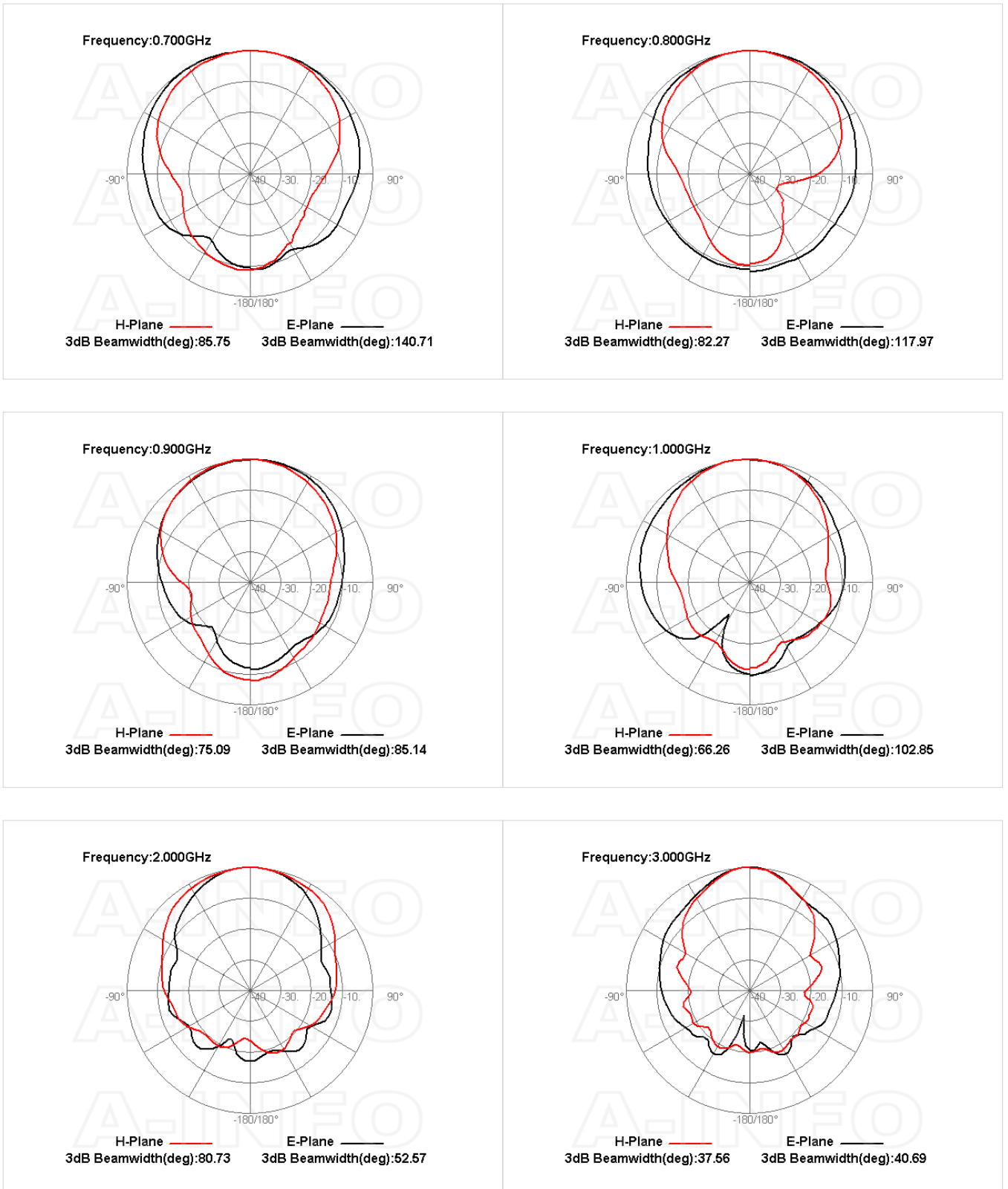

Frequency:4.000GHz

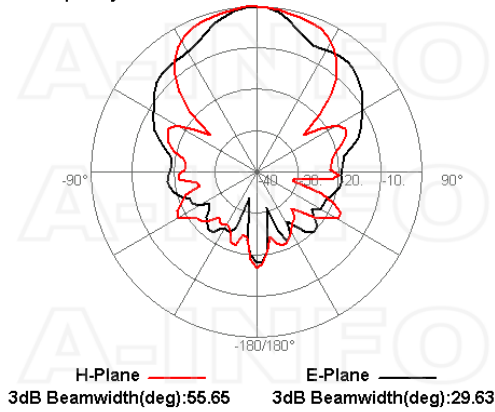

Frequency:5.000GHz

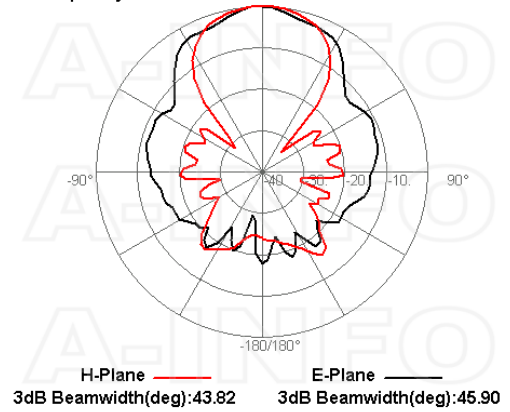

Frequency:6.000GHz

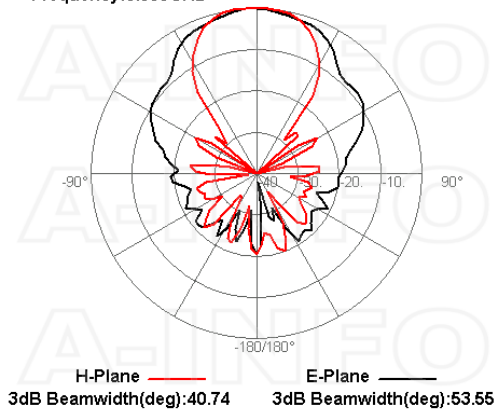

Frequency:7.000GHz

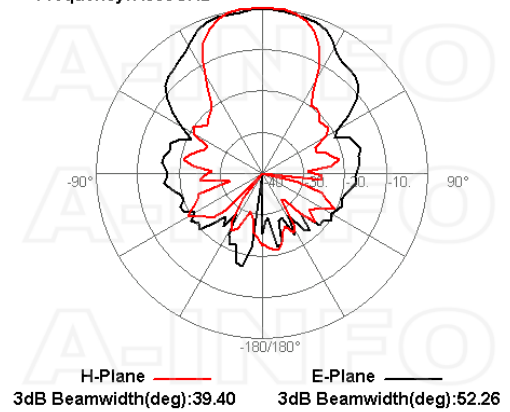

Frequency:8.000GHz

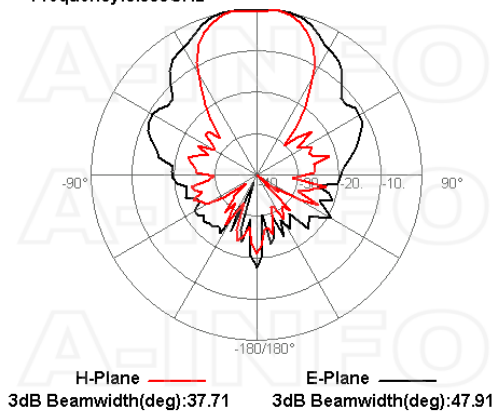

Frequency:9.000GHz

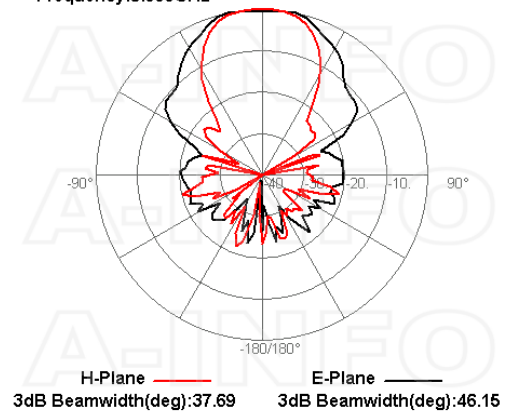

Frequency:10.000GHz

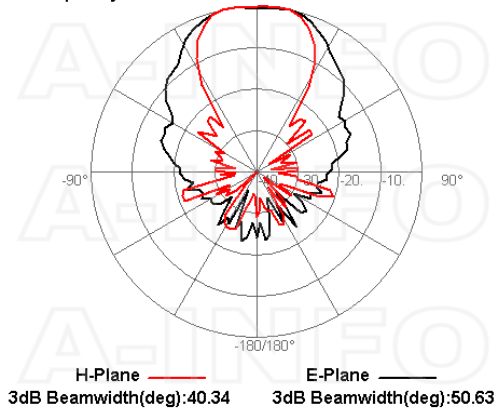

Frequency:12.000GHz

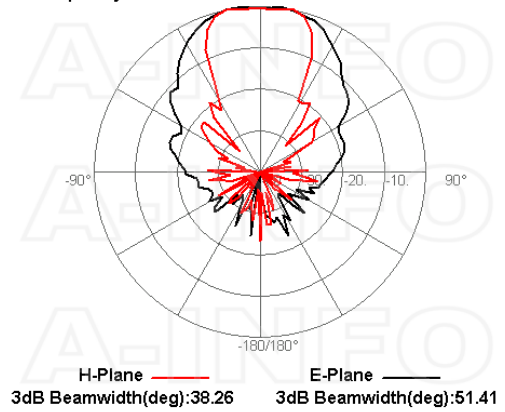

Frequency:14.000GHz

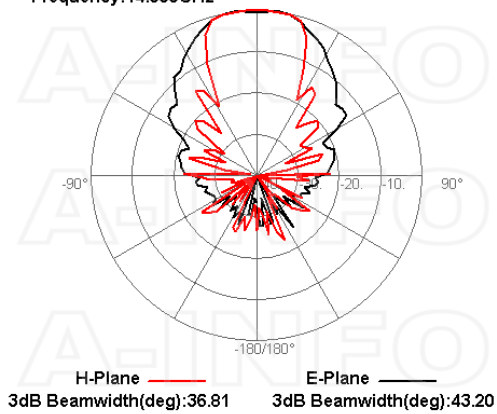

Frequency:16.000GHz

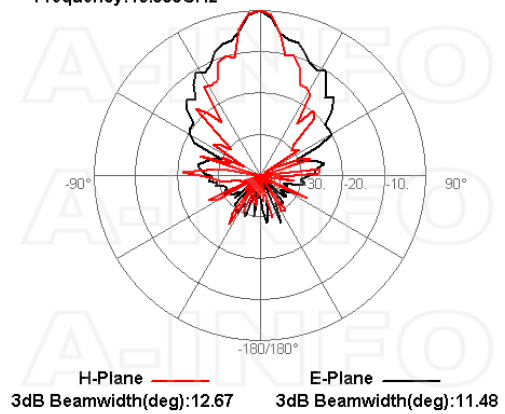

Frequency:18.000GHz

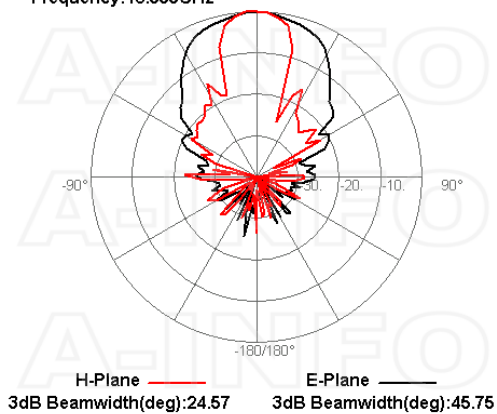

Related Products



LB-10180-L L type mounting bracket



LB-10180-MA Stinger Type Mounting Bracket



Tripod_15Kg Al Alloy Tripod



3033HL Wooden Tripod



3033QM Wooden Tripod Metalfree



Carrying Case_LB-8180 Al Alloy Carrying Case



NM-NM-A050-1000 Flexible Cable Assembly 1000mm DC-18GHz N Male to N Male



NM-NM-A050-1500 Flexible Cable Assembly 1500mm DC-18GHz N Male to N Male



NM-NM-A050-2000 Flexible Cable Assembly 2000mm DC-18GHz N Male to N Male



NM-NM-A050-3000 Flexible Cable Assembly 3000mm DC-18GHz N Male to N Male



NM-NM-A050-5000 Flexible Cable Assembly 5000mm DC-18GHz N Male to N Male



NM-NM-A050-10000 Flexible Cable Assembly 10000mm DC-18GHz N Male to N Male



NM-NM-A050-20000 Flexible Cable Assembly 20000mm DC-18GHz N Male to N Male



NM-NM-A100-500 Flexible Cable Assembly 500mm DC-18GHz N Male to N Male



NM-NM-A100-1000 Flexible Cable Assembly 1000mm DC-18GHz N Male to N Male



NM-NM-A100-1500 Flexible Cable Assembly 1500mm DC-18GHz N Male to N Male



NM-NM-A100-2000 Flexible Cable Assembly 2000mm DC-18GHz N Male to N Male



NM-NM-A100-3000 Flexible Cable Assembly 3000mm DC-18GHz N Male to N Male



NM-NM-A100-5000 Flexible Cable Assembly 5000mm DC-18GHz N Male to N Male



NM-NM-A100-10000 Flexible Cable Assembly 10000mm DC-18GHz N Male to N Male



NM-NM-A100-20000 Flexible Cable Assembly 20000mm DC-18GHz N Male to N Male

Similar Products



LB-7180-NFSPO Broadband Horn Antenna 0.7-18GHz 12dB Gain N Type Female



LB-7180-SF Broadband Horn Antenna 0.7-18.0 GHz 12dB Gain SMA Female



LB-7180-SFSPO Broadband Horn Antenna 0.7-18GHz 12dB Gain SMA Female



LB-8180-NF Broadband Horn Antenna 0.8-18GHz 12dB Gain N Type Female



LB-8180-NFSPO Broadband Horn Antenna 0.8-18GHz 12dB Gain N Type Female



LB-8180-SF Broadband Horn Antenna 0.8-18GHz 12dB Gain SMA Female



LB-8180-SFSPO Broadband Horn Antenna 0.8-18GHz 12dB Gain SMA Female



LB-1080-NF Broadband Horn Antenna 1-8GHz 11dB Gain N Type Female



LB-1080-NFSPO Broadband Horn Antenna 1-8GHz 11dB Gain N Type Female

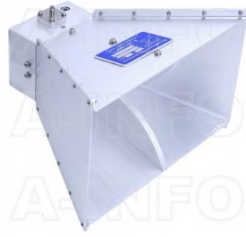

LB-1080-SF Broadband Horn Antenna 1-8GHz 11dB Gain SMA Female



LB-1080-SFSPO Broadband Horn Antenna 1-8GHz 11dB Gain SMA Female



LB-1080-M-NF Broadband Horn Antenna 1-8GHz 10dB Gain N Type Female



LB-1080-M-SF Broadband Horn Antenna 1-8GHz 10dB Gain SMA Female



LB-10180-NF Broadband Horn Antenna 1-18GHz 11dB Gain N Type Female



LB-10180-NFSPO Broadband Horn Antenna 1-18GHz 11dB Gain N Type Female



LB-10180-NFSPS Broadband Horn Antenna 1-18GHz 11dB Gain N Type Female



LB-10180-NFP Broadband Horn Antenna 1-18GHz 11dB Gain N Type Female



LB-10180-SF Broadband Horn Antenna 1-18GHz 11dB Gain SMA Female



LB-10180-SFSPO Broadband Horn Antenna 1-18GHz 11dB Gain SMA Female



LB-OSJ-10180-NF Open Boundary Quad-Ridged Dual Polarization Horn Antenna 1-18GHz 10dB Gain N Type Female



LB-OSJ-10180-SF Open Boundary Quad-Ridged Dual Polarization Horn Antenna 1-18GHz 10dB Gain SMA Female

About this Datasheet

<ul style="list-style-type: none">● Product Information <p>Product Link: https://www.ainfoinc.com/lb-7180-nf-broadband-horn-antenna-0-7-18-0-ghz-12db-gain-n-type-female Data subject to change without notice. © A-INFO INC. 2024. All Rights Reserved</p>	<ul style="list-style-type: none">● Contact Us <p>Address: 60 Tesla, Irvine, CA 92618, USA</p> <p>Website: www.ainfoinc.com</p> <p>Email: sales@ainfoinc.com</p>	<ul style="list-style-type: none">● Phone & Fax <p>Phone: +1-949-639-9688 +1-949-639-9608</p> <p>Fax: +1-949-639-9670</p>
--	---	--