

### LB-10200-NF Broadband Horn Antenna 1-20GHz 11dB Gain N Type Female

Broadband Horn Antenna Operating From 1GHz to 20GHz With a Nominal 11dB Gain With N Type Female Connector

## Product Information

SKU	LB-10200-NF
-----	-------------

## Description

Broadband horn antenna LB-10200-NF, operating from 1 to 20GHz with a nominal 11dB gain and low VSWR 1.5:1 with N Type Female output connector. The model LB-10200-NF has uniform gain through its frequency span, providing efficient performance characteristics and directionality. It can handle 300W continuously and 500W peak power. Constructed of lightweight corrosion-resistant aluminum, the antenna will provide years of trouble-free indoor and outdoor service. This broadband horn antenna is linearly polarized and ideally suited for EMI testing, direction finding, surveillance, antenna gain and pattern measurements and other applications.

## Technical Specification

Electrical Specification		Interface	
Frequency, Min (GHz)	1	Output Type	Coaxial
Frequency, Max (GHz)	20	Connector	N Type
Gain, Typ (dBi)	11	Connector Gender	Female
Polarization	Linear	Mechanical Specification	
3dB Beamwidth, E-Plane, Min (Deg.)	11	Body Material	Al
3dB Beamwidth, E-Plane, Max (Deg.)	77	Finish	Chemical Conversion Coating and Sand Blasting
3dB Beamwidth, H-Plane, Min (Deg.)	13	Size, W (mm)	244
3dB Beamwidth, H-Plane, Max (Deg.)	58	Size, H (mm)	160
Cross Pol. Isolation, Typ (dB)	25	Size, L (mm)	204
VSWR, Typ	1.5:1	Weight, (kg)	1.45
Impedance, (Ohm)	50		
Power Handling, CW, (W)	300		
Power Handling, Peak, (W)	500		

## Additional Information

Application	General Purpose Indoor & Outdoor, Fixed	Solution for	Gain Reference Antenna Measurement Reflector Feed Far-field Measurement System Intergration
-------------	---	--------------	---

## Outline Drawing

N-Female Output (P/N: LB-10200-NF)

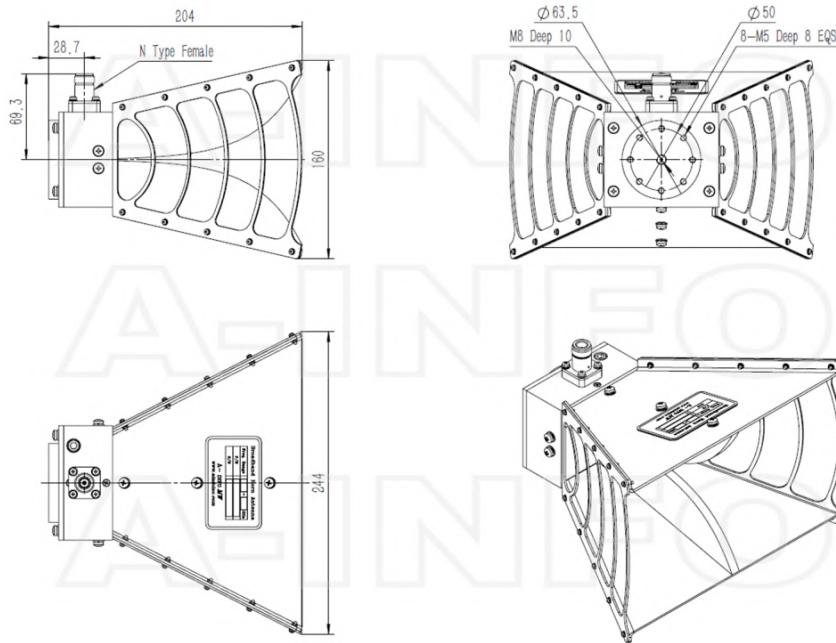

N-Female Output with L Type Mounting Bracket (Option, P/N: LB-10180-L)

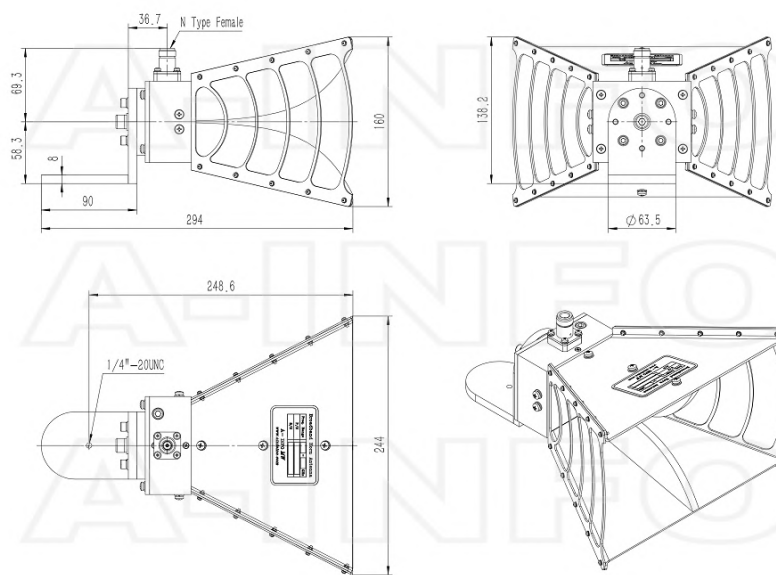

N-Female Output with Round Type Mounting Bracket (Option, P/N: LB-10180-MA)

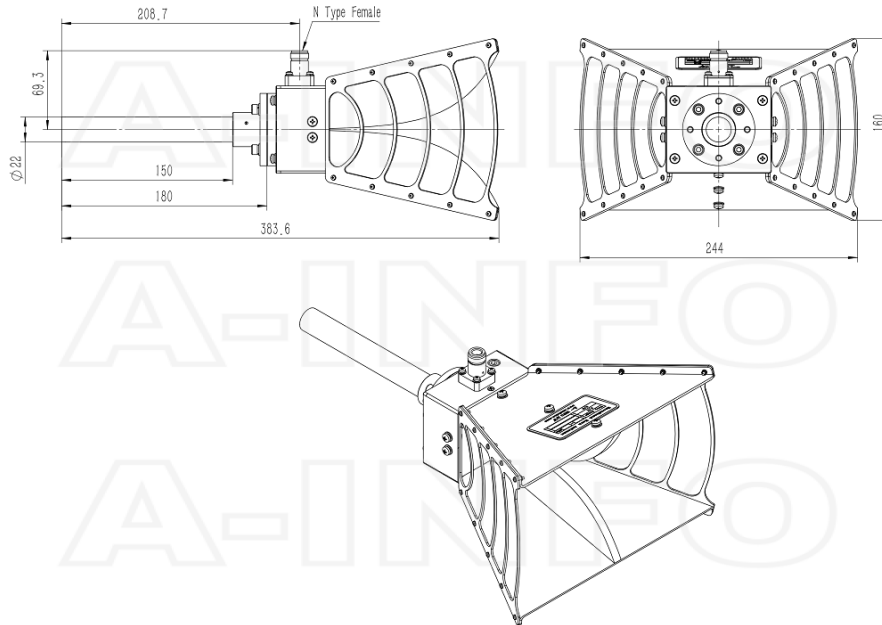

## Typical Test Results

### Gain

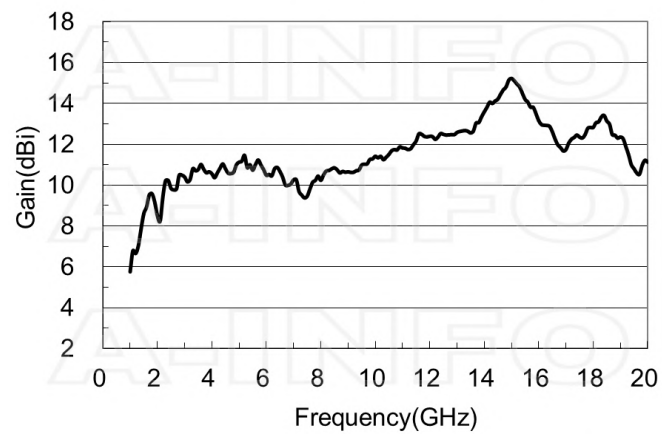

## Antenna Factor

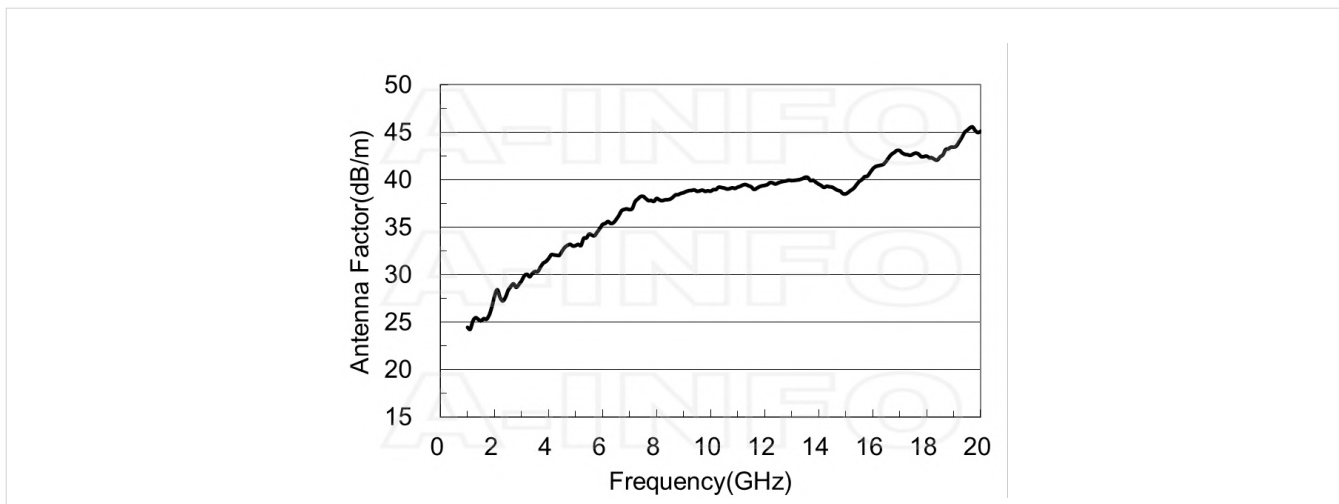

## Antenna Factor (Table)

Frequency(GHz)	Gain(dBi )	Antenna Factor(dB/m)
1.0	6.17	24.04
2.0	8.75	27.48
3.0	9.95	29.81
4.0	10.00	32.25
5.0	10.18	34.01
6.0	9.49	36.28
7.0	9.53	37.58
8.0	10.56	37.71
9.0	10.64	38.66
10.0	11.21	39.00
12.0	12.30	39.49
14.0	13.51	39.63
16.0	13.20	41.09
18.0	12.06	43.25
20.0	13.01	43.22

## Field Strength

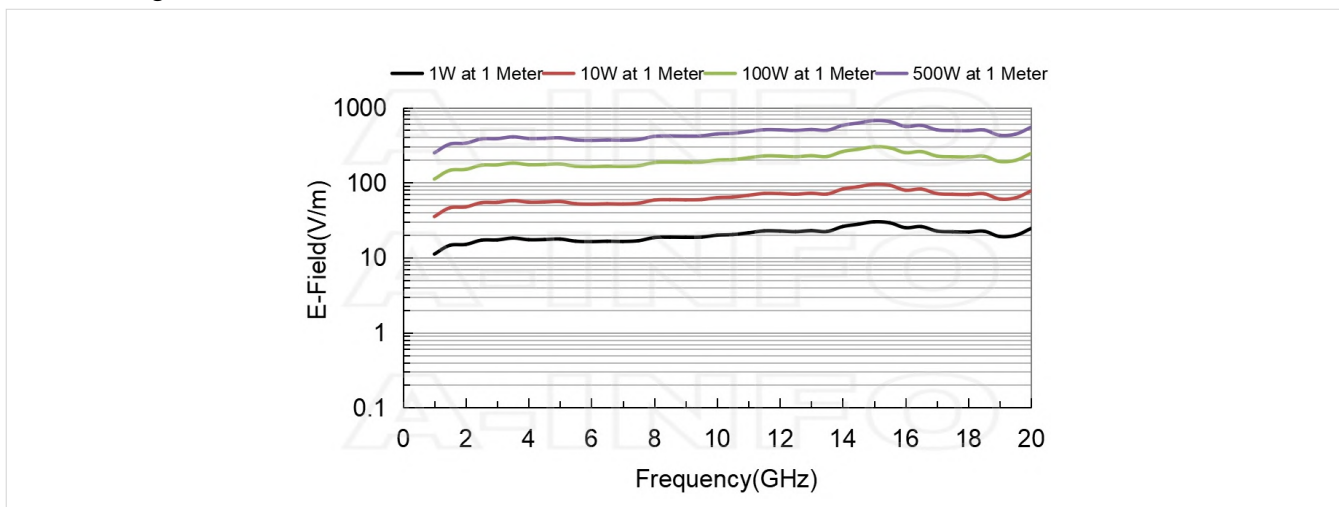

## Cross Polarization Isolation

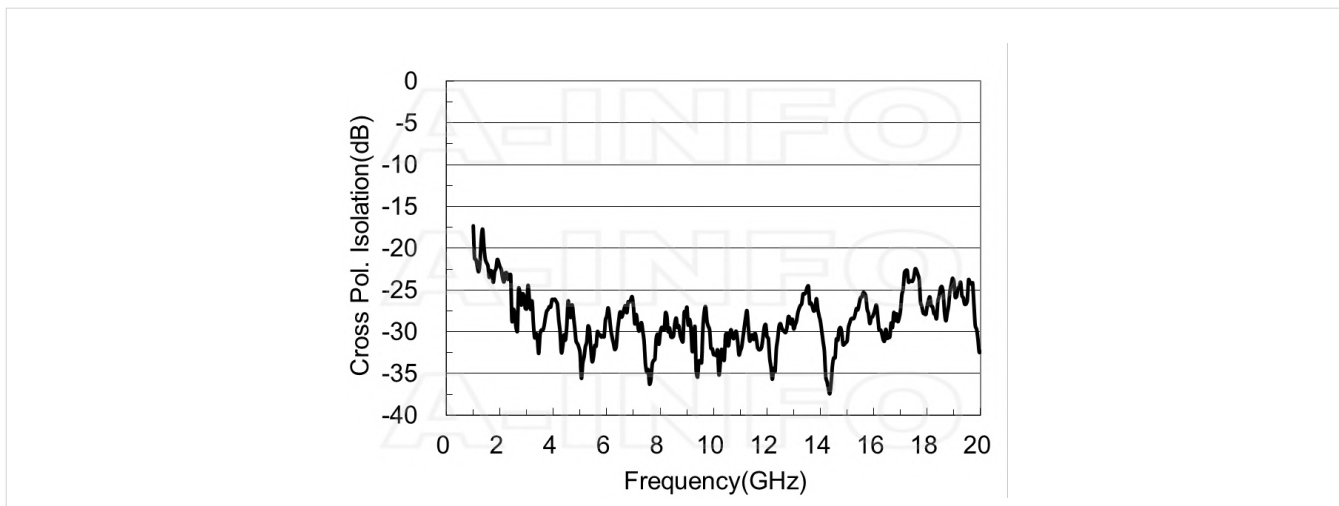

## VSWR

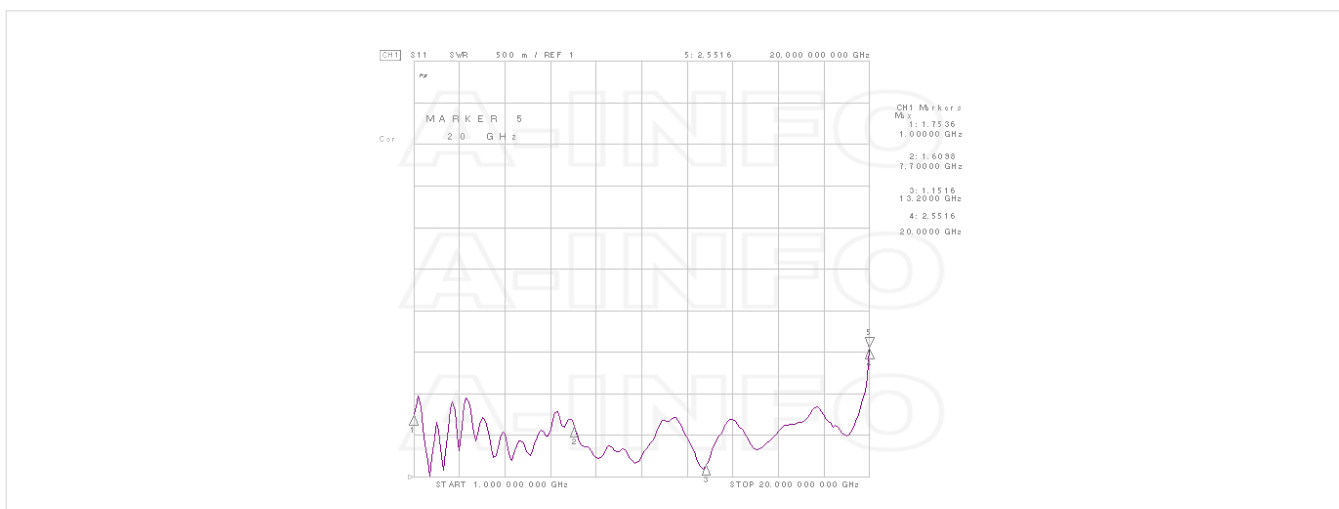

## Pattern

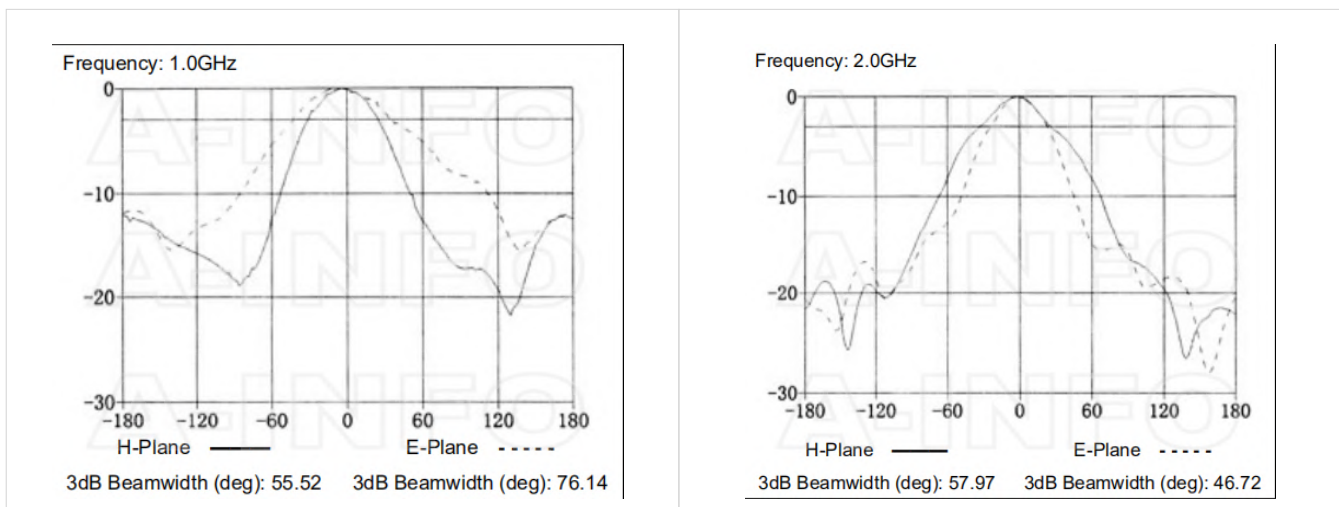

Frequency: 3.0GHz

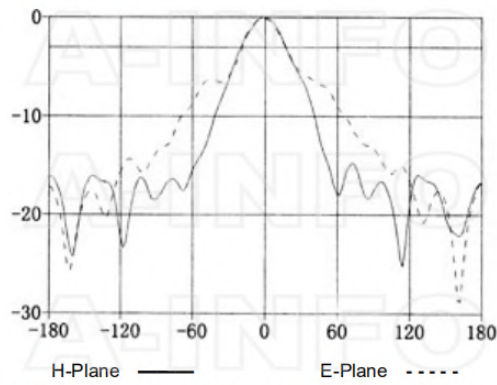

3dB Beamwidth (deg): 36.97    3dB Beamwidth (deg): 35.61

Frequency: 4.0GHz

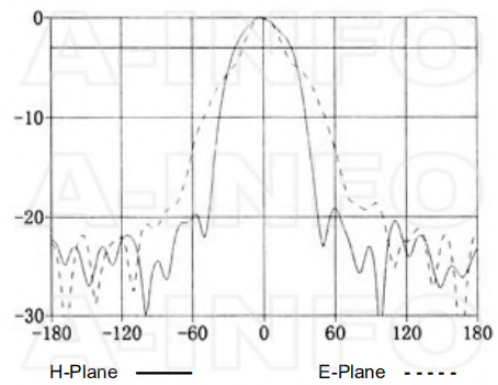

3dB Beamwidth (deg): 47.09    3dB Beamwidth (deg): 34.18

Frequency: 5.0GHz

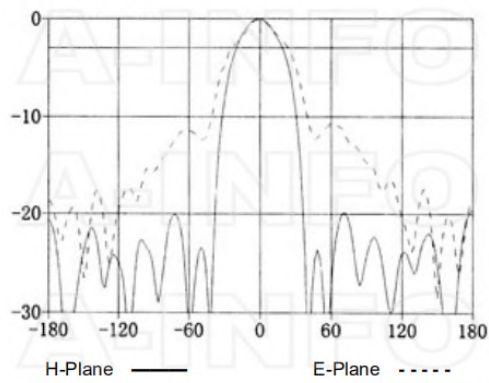

3dB Beamwidth (deg): 38.81    3dB Beamwidth (deg): 46.90

Frequency: 6.0GHz

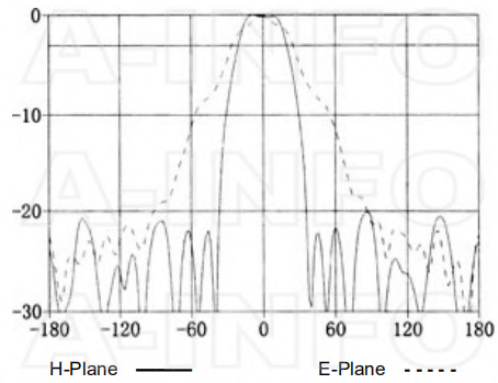

3dB Beamwidth (deg): 40.35    3dB Beamwidth (deg): 51.11

Frequency: 7.0GHz

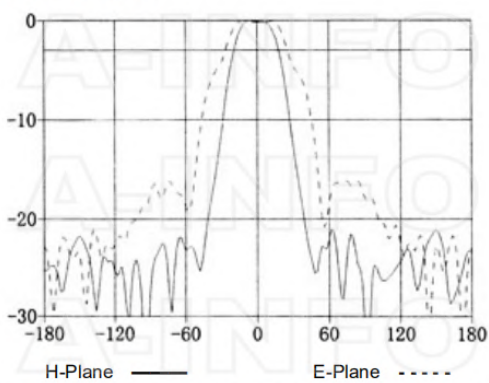

3dB Beamwidth (deg): 37.43    3dB Beamwidth (deg): 51.60

Frequency: 8.0GHz

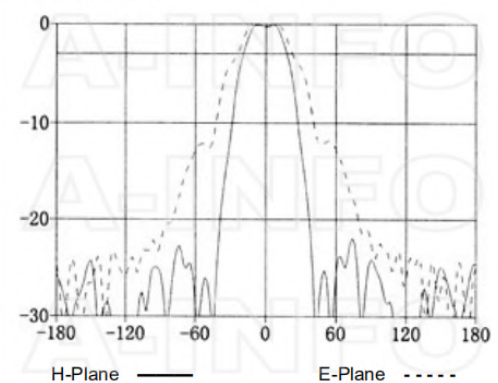

3dB Beamwidth (deg): 37.44    3dB Beamwidth (deg): 46.49

Frequency: 9.0GHz

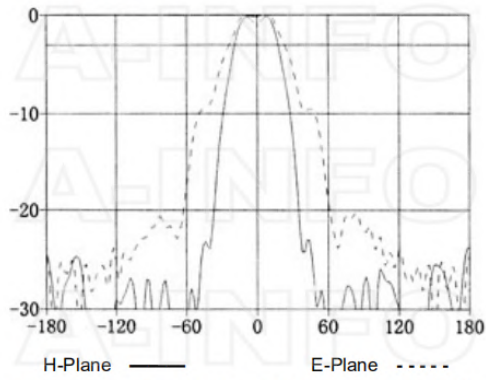

3dB Beamwidth (deg): 36.98    3dB Beamwidth (deg): 46.61

Frequency: 10.0GHz

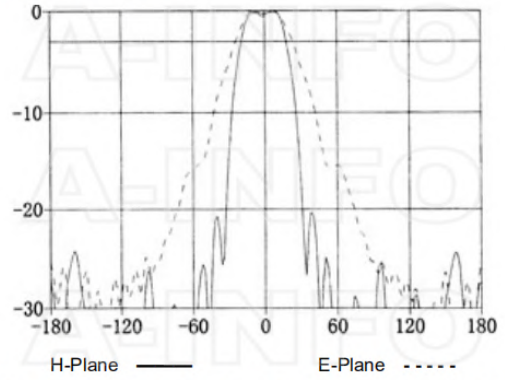

3dB Beamwidth (deg): 37.31    3dB Beamwidth (deg): 47.33

Frequency: 12.0GHz

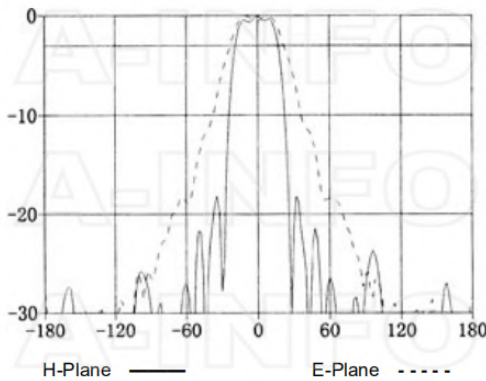

3dB Beamwidth (deg): 35.91    3dB Beamwidth (deg): 44.75

Frequency: 14.0GHz

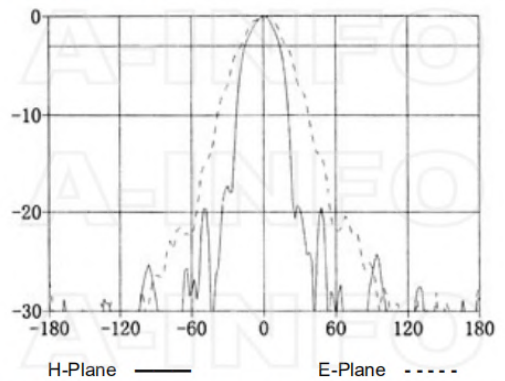

3dB Beamwidth (deg): 28.69    3dB Beamwidth (deg): 37.31

Frequency: 16.0GHz

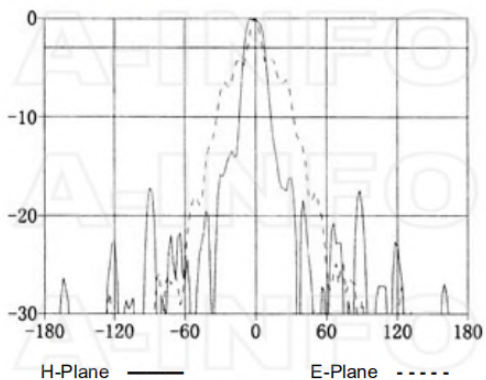

3dB Beamwidth (deg): 17.11    3dB Beamwidth (deg): 12.42

Frequency: 18.0GHz

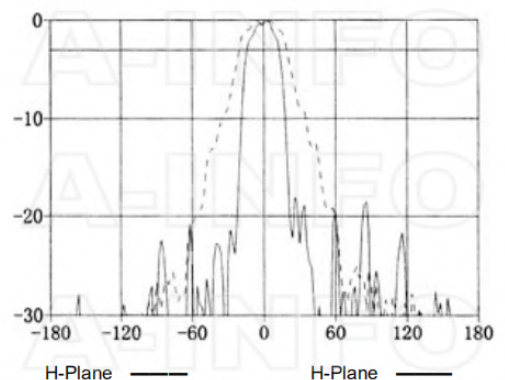

3dB Beamwidth (deg): 26.90    3dB Beamwidth (deg): 40.07

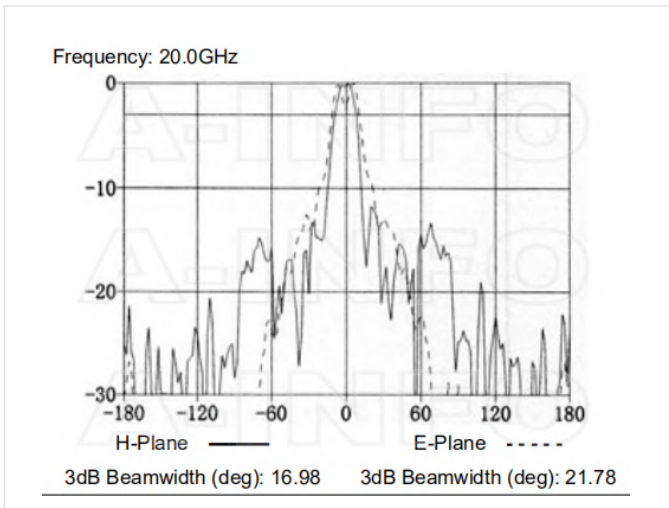

## Related Products



LB-10180-L L type mounting bracket



LB-10180-MA Stinger Type Mounting Bracket



Tripod\_15Kg Al Alloy Tripod



3033HL Wooden Tripod



3033QM Wooden Tripod Metalfree



Carrying Case\_LB-10180 Al Alloy Carrying Case



NM-NM-A050-1000 Flexible Cable Assembly 1000mm DC-18GHz N Male to N Male



NM-NM-A050-1500 Flexible Cable Assembly 1500mm DC-18GHz N Male to N Male



NM-NM-A050-2000 Flexible Cable Assembly 2000mm DC-18GHz N Male to N Male



NM-NM-A050-3000 Flexible Cable Assembly 3000mm DC-18GHz N Male to N Male



NM-NM-A050-5000 Flexible Cable Assembly 5000mm DC-18GHz N Male to N Male



NM-NM-A050-10000 Flexible Cable Assembly 10000mm DC-18GHz N Male to N Male



NM-NM-A050-20000 Flexible Cable Assembly 20000mm DC-18GHz N Male to N Male



NM-NM-A100-500 Flexible Cable Assembly 500mm DC- 18GHz N Male to N Male



NM-NM-A100-1000 Flexible Cable Assembly 1000mm DC-18GHz N Male to N Male



NM-NM-A100-1500 Flexible Cable Assembly 1500mm DC-18GHz N Male to N Male



NM-NM-A100-2000 Flexible Cable Assembly 2000mm DC-18GHz N Male to N Male



NM-NM-A100-3000 Flexible Cable Assembly 3000mm DC-18GHz N Male to N Male



NM-NM-A100-5000 Flexible Cable Assembly 5000mm DC-18GHz N Male to N Male



NM-NM-A100-10000 Flexible Cable Assembly 10000mm DC-18GHz N Male to N Male



NM-NM-A100-20000 Flexible Cable Assembly 20000mm DC-18GHz N Male to N Male

## Similar Products



LB-7180-NF Broadband Horn Antenna 0.7-18.0 GHz 12dB Gain N Type Female



LB-7180-NFSPO Broadband Horn Antenna 0.7-18GHz 12dB Gain N Type Female



LB-7180-SF Broadband Horn Antenna 0.7-18.0 GHz 12dB Gain SMA Female



LB-7180-SFSPO Broadband Horn Antenna 0.7-18GHz 12dB Gain SMA Female



LB-8180-NF Broadband Horn Antenna 0.8-18GHz 12dB Gain N Type Female



LB-8180-NFSPO Broadband Horn Antenna 0.8-18GHz 12dB Gain N Type Female



LB-8180-SF Broadband Horn Antenna 0.8-18GHz 12dB Gain SMA Female



LB-8180-SFSPO Broadband Horn Antenna 0.8-18GHz 12dB Gain SMA Female



LB-10180-NF Broadband Horn Antenna 1-18GHz 11dB Gain N Type Female



LB-10180-NFSPO Broadband Horn Antenna 1-18GHz 11dB Gain N Type Female



LB-10180-NFSPS Broadband Horn Antenna 1-18GHz 11dB Gain N Type Female

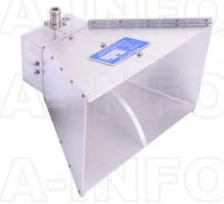

LB-10180-NFP Broadband Horn Antenna 1-18GHz 11dB Gain N Type Female



LB-10180-SF Broadband Horn Antenna 1-18GHz 11dB Gain SMA Female



LB-10180-SFSPO Broadband Horn Antenna 1-18GHz 11dB Gain SMA Female



LB-10200-NFSPO Broadband Horn Antenna 1-20GHz 11dB Gain N Type Female



LB-10200-SF Broadband Horn Antenna 1-20GHz 11dB Gain SMA Female



LB-10200-SFSPO Broadband Horn Antenna 1-20GHz 11dB Gain SMA Female



LB-OSJ-10180-NF Open Boundary Quad-Ridged Dual Polarization Horn Antenna 1-18GHz 10dB Gain N Type Female



LB-OSJ-10180-SF Open Boundary Quad-Ridged Dual Polarization Horn Antenna 1-18GHz 10dB Gain SMA Female



LB-OSJ-10200-NF Open Boundary Quad-Ridged Dual Polarization Horn Antenna 1-20GHz 10dB Gain N Type Female



LB-OSJ-10200-SF Open Boundary  
 Quad-Ridged Dual Polarization  
 Horn Antenna 1-20GHz 10dB  
 Gain SMA Female

## About this Datasheet

<ul style="list-style-type: none"> <li>• <b>Product Information</b>            Product Link:  <a href="https://www.ainfoinc.com/lb-10200-nf-broadband-horn-antenna-1-20-ghz-11db-gain-n-type-female">https://www.ainfoinc.com/lb-10200-nf-broadband-horn-antenna-1-20-ghz-11db-gain-n-type-female</a>            Data subject to change without notice.            © A-INFO INC. 2024. All Rights Reserved</li> </ul>	<ul style="list-style-type: none"> <li>• <b>Contact Us</b>            Address:            60 Tesla, Irvine, CA 92618,            USA             Website:  <a href="http://www.ainfoinc.com">www.ainfoinc.com</a>             Email:  <a href="mailto:sales@ainfoinc.com">sales@ainfoinc.com</a></li> </ul>	<ul style="list-style-type: none"> <li>• <b>Phone &amp; Fax</b>            Phone:            +1-949-639-9688            +1-949-639-9608             Fax:            +1-949-639-9670</li> </ul>
---	---	--