

LB-20180H-NFSPO Broadband Horn Antenna 2-18GHz 17dB Gain N Type Female



Broadband Horn Antenna Operating From 2GHz to 18GHz With a Nominal 17dB Gain With N Type Female Connector

Product Information

SKU	LB-20180H-NFSPO
-----	-----------------

Description

Broadband horn antenna LB-20180H-NFSPO, operating from 2 to 18GHz with a nominal 17dB gain and low VSWR 1.5:1 with N Type Female output connector. The model LB-20180H-NFSPO has uniform gain through its frequency span, providing efficient performance characteristics and directionality. It can handle 150W continuously and 300W peak power. Constructed of lightweight corrosion-resistant aluminum, the horn comes with a specially designed weatherproof radome which provides excellent protection against the rain and dust but has very little loss across the full operating frequency band. This broadband horn antenna is linearly polarized and ideally suited for EMI testing, direction finding, surveillance, antenna gain and pattern measurements and other applications.

Technical Specification

Electrical Specification		Interface	
Frequency, Min (GHz)	2	Output Type	Coaxial
Frequency, Max (GHz)	18	Connector	N Type
Gain, Typ (dBi)	17	Connector Gender	Female
Polarization	Linear	Mechanical Specification	
3dB Beamwidth, E-Plane, Min (Deg.)	13	Body Material	Al
3dB Beamwidth, E-Plane, Max (Deg.)	50	Finish	Chemical Conversion Coating and Sand Blasting, Gray Paint
3dB Beamwidth, H-Plane, Min (Deg.)	9	Size, W (mm)	195
3dB Beamwidth, H-Plane, Max (Deg.)	54	Size, H (mm)	183
Cross Pol. Isolation, Typ (dB)	25	Size, L (mm)	442.5
VSWR, Typ	1.5:1	Weight, (kg)	1.93
Impedance, (Ohm)	50		
Power Handling, CW, (W)	150		
Power Handling, Peak, (W)	300		

Additional Information

Application	Outdoor, Waterproof and Dustproof, Fixed	Solution for	Gain Reference Antenna Measurement Reflector Feed Far-field Measurement System Intergration
-------------	--	--------------	---

Outline Drawing

N-Female Output with Radome (Option, P/N: LB-20180H-NFSPO, Outdoor Application)

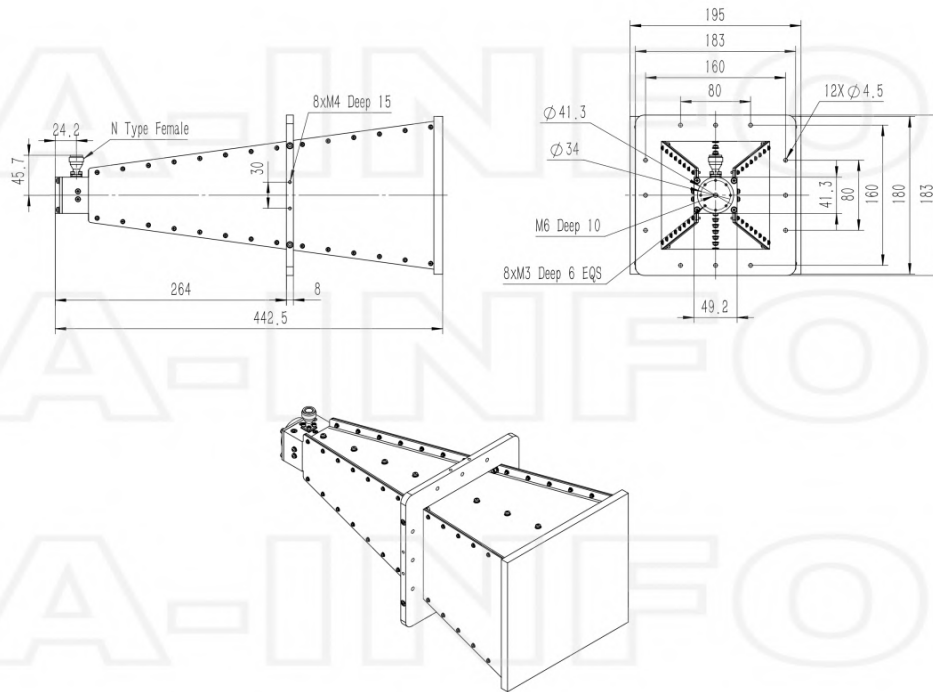

N-Female Output with L Type Mounting Bracket & Radome (Option, P/N: LB-20180H-L & LB-20180H-NFSP0, Outdoor Application)

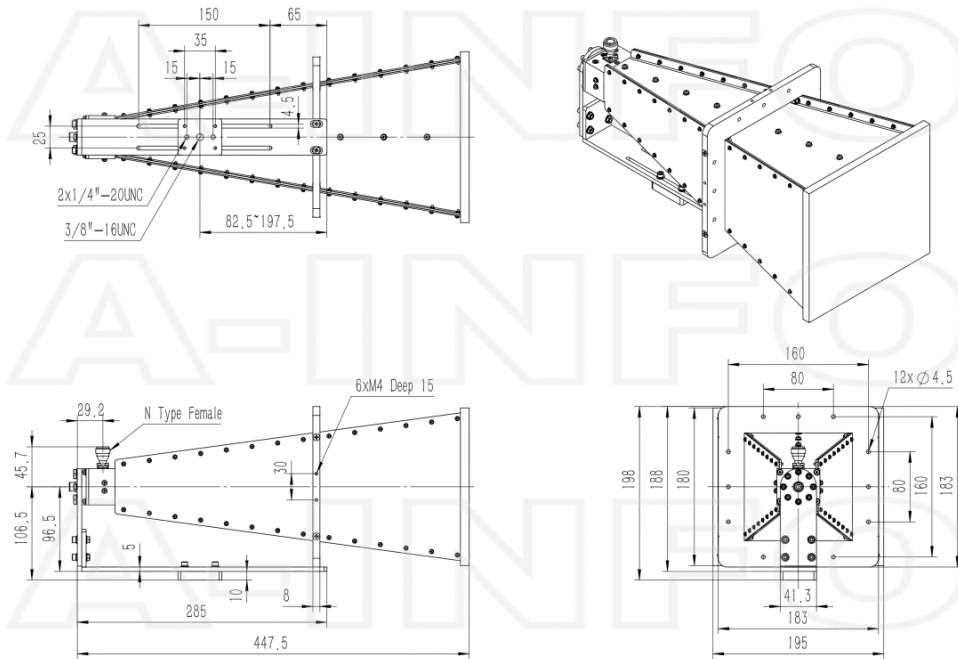

Typical Test Results

Gain

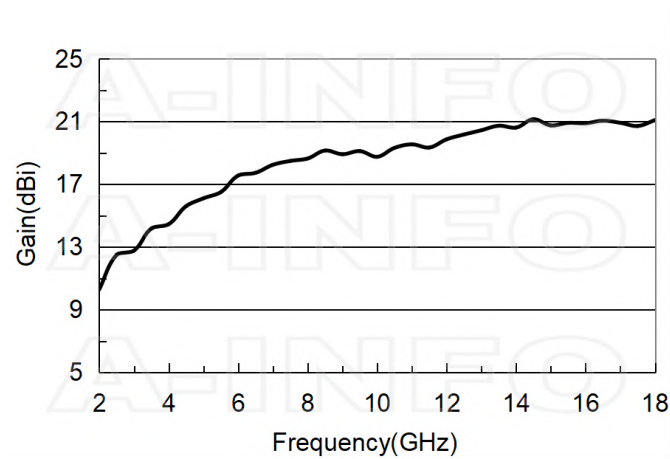

Antenna Factor

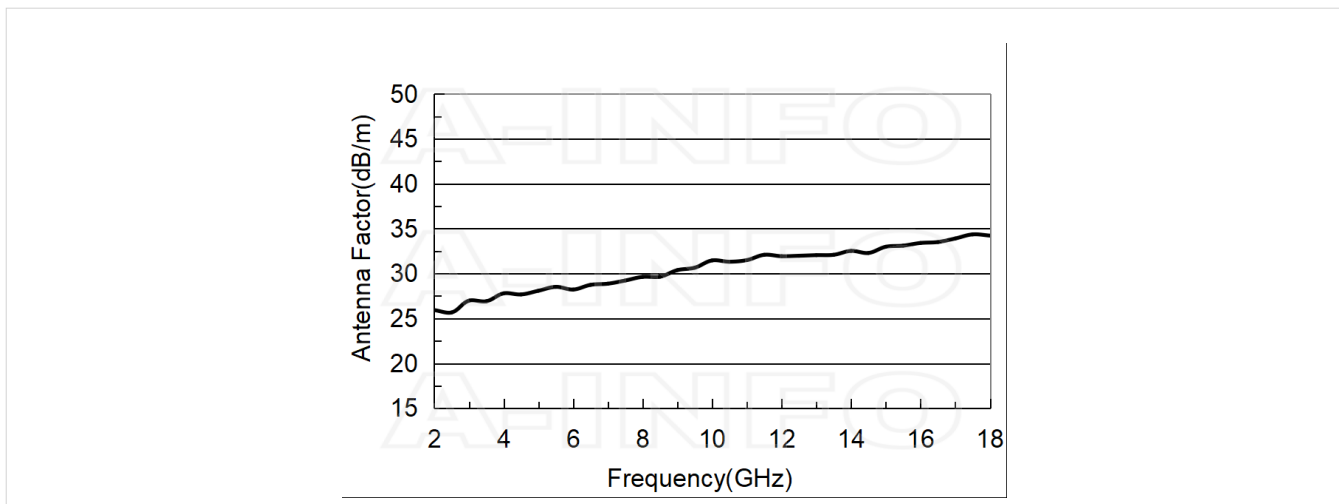

Antenna Factor (Table)

Frequency(GHz)	Gain(dBi)	Antenna Factor(dB/m)
2.0	10.30	25.93
3.0	12.77	26.98
4.0	14.46	27.79
5.0	16.10	28.09
6.0	17.55	28.22
7.0	18.24	28.87
8.0	18.64	29.63
9.0	18.92	30.38
10.0	18.75	31.46
12.0	19.86	31.93
14.0	20.61	32.52
16.0	20.89	33.40
18.0	21.09	34.22

Cross Polarization Isolation

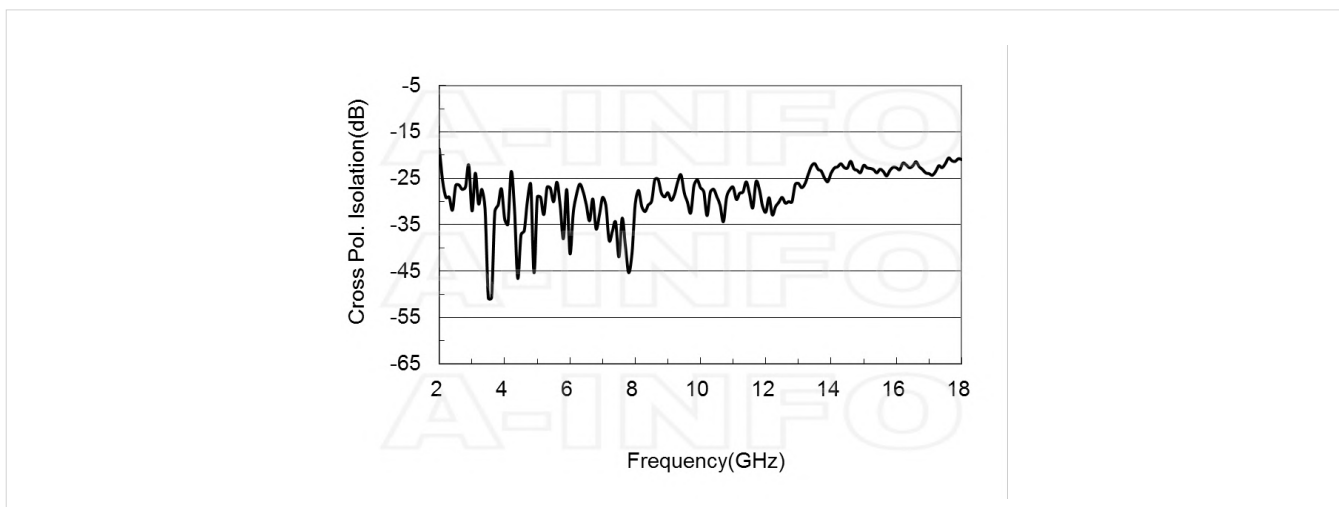

VSWR

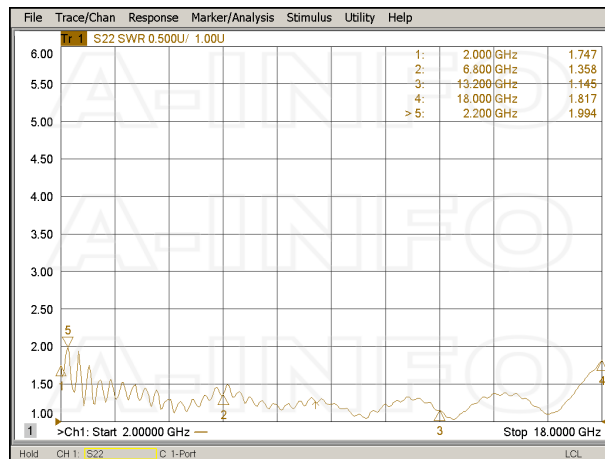

Pattern

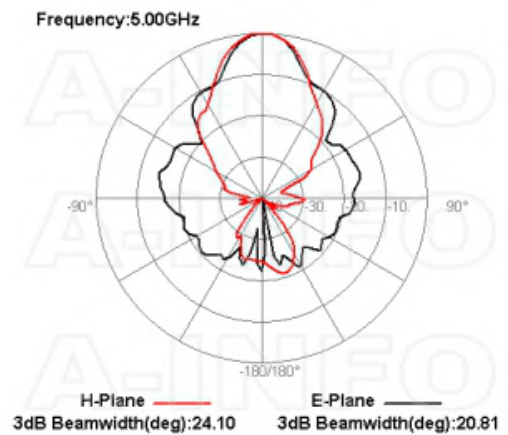
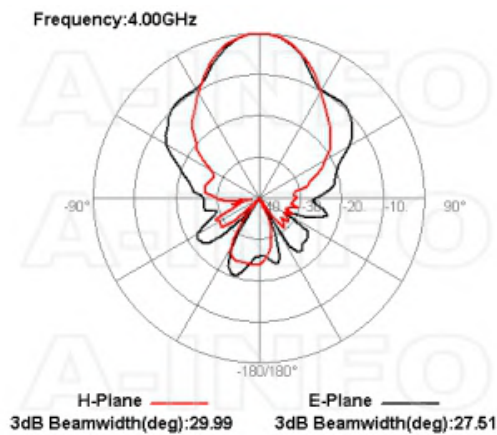
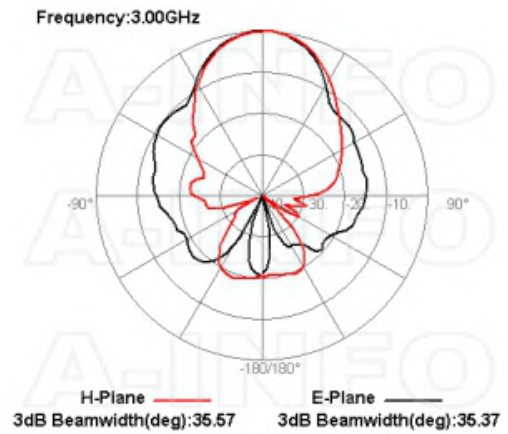
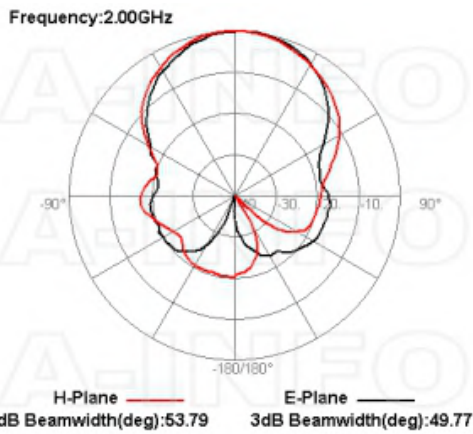

Frequency:6.00GHz

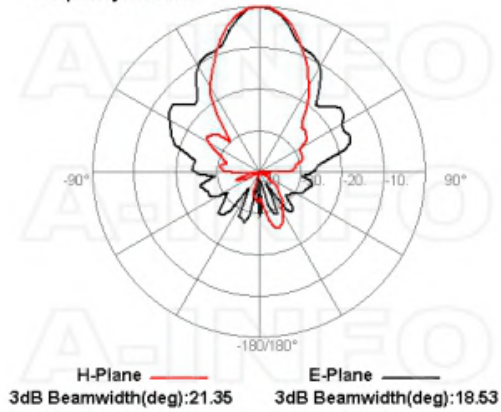

Frequency:7.00GHz

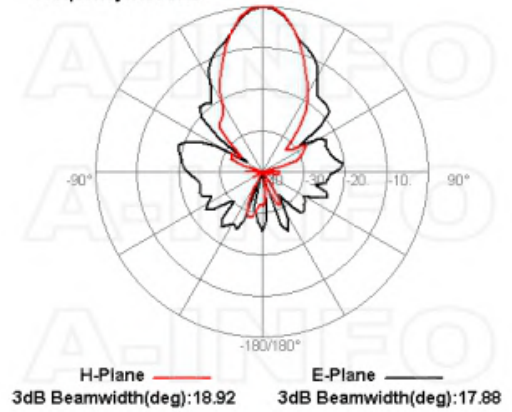

Frequency:8.00GHz

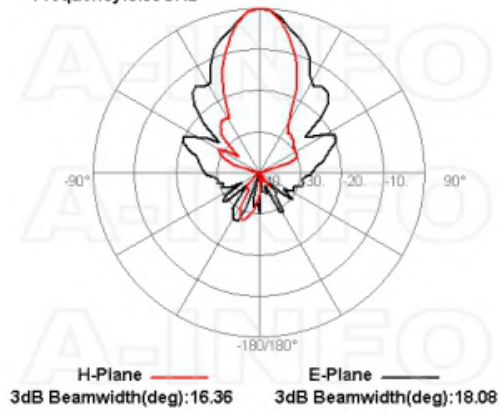

Frequency:9.00GHz

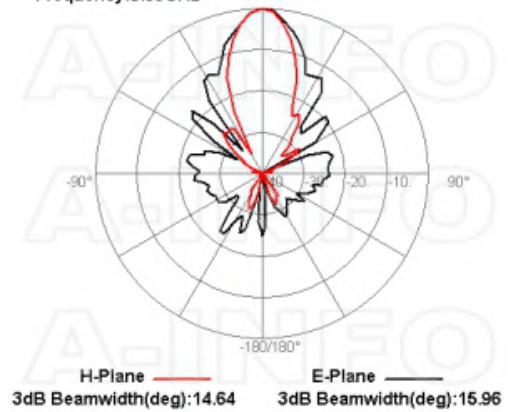

Frequency:10.00GHz

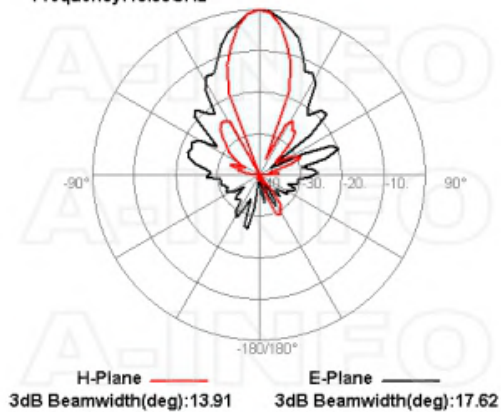

Frequency:12.00GHz

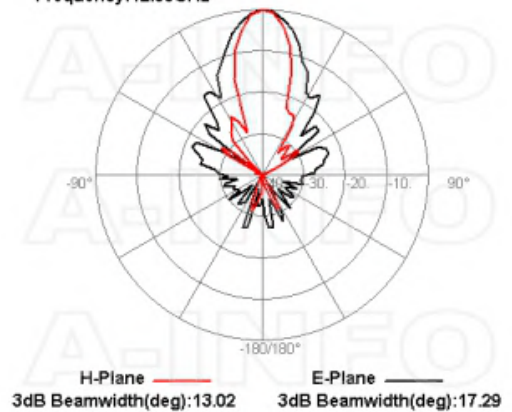

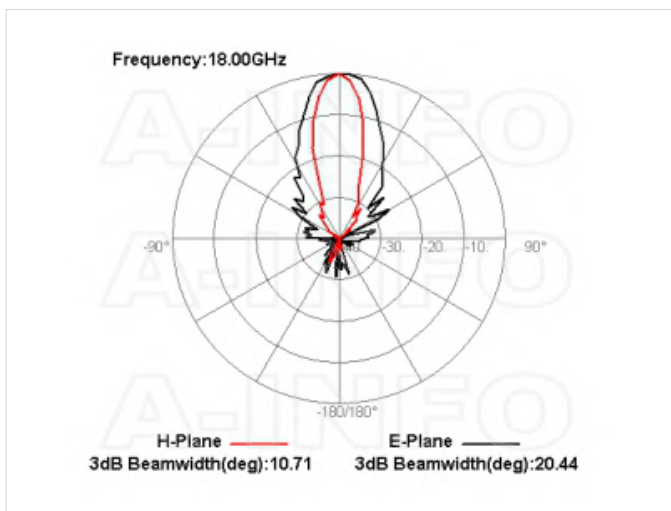

Related Products



LB-20180H-L L type mounting bracket



Tripod_15Kg Al Alloy Tripod



3033HL Wooden Tripod



3033QM Wooden Tripod Metalfree



NM-NM-A050-1000 Flexible Cable Assembly 1000mm DC-18GHz N Male to N Male



NM-NM-A050-1500 Flexible Cable Assembly 1500mm DC-18GHz N Male to N Male



NM-NM-A050-2000 Flexible Cable Assembly 2000mm DC-18GHz N Male to N Male



NM-NM-A050-3000 Flexible Cable Assembly 3000mm DC-18GHz N Male to N Male



NM-NM-A050-5000 Flexible Cable Assembly 5000mm DC-18GHz N Male to N Male



NM-NM-A050-10000 Flexible Cable Assembly 10000mm DC-18GHz N Male to N Male



NM-NM-A050-20000 Flexible Cable Assembly 20000mm DC-18GHz N Male to N Male



NM-NM-A100-500 Flexible Cable Assembly 500mm DC-18GHz N Male to N Male



NM-NM-A100-1000 Flexible Cable Assembly 1000mm DC-18GHz N Male to N Male



NM-NM-A100-1500 Flexible Cable Assembly 1500mm DC-18GHz N Male to N Male



NM-NM-A100-2000 Flexible Cable Assembly 2000mm DC-18GHz N Male to N Male



NM-NM-A100-3000 Flexible Cable Assembly 3000mm DC-18GHz N Male to N Male



NM-NM-A100-5000 Flexible Cable Assembly 5000mm DC-18GHz N Male to N Male



NM-NM-A100-10000 Flexible Cable Assembly 10000mm DC-18GHz N Male to N Male



NM-NM-A100-20000 Flexible Cable Assembly 20000mm DC-18GHz N Male to N Male

Similar Products



LB-20180-SF Broadband Horn Antenna 2-18GHz 12dB Gain SMA Female



LB-20180-SFP Broadband Horn Antenna 2-18GHz 12dB Gain SMA Female



LB-20180-SFSP0 Broadband Horn Antenna 2-18GHz 12dB Gain SMA Female



LB-20180-NF Broadband Horn Antenna 2-18GHz 12dB Gain N Type Female



LB-20180-NFP Broadband Horn Antenna 2-18GHz 12dB Gain N Type Female



LB-20180-NFSP0 Broadband Horn Antenna 2-18GHz 12dB Gain N Type Female



LB-20180-NFSPS Broadband Horn Antenna 2-18GHz 12dB Gain N Type Female



LB-20180H-SF Broadband Horn Antenna 2-18GHz 17dB Gain SMA Female



LB-20180H-SFSP0 Broadband Horn Antenna 2-18GHz 17dB Gain SMA Female



LB-20180H-SFSPS Broadband Horn Antenna 2-18GHz 17dB Gain SMA Female



LB-20180H-NF Broadband Horn Antenna 2-18GHz 17dB Gain N Type Female



LB-20200-SF Broadband Horn Antenna 2-20GHz 12dB Gain SMA Female



LB-20200-SFP Broadband Horn Antenna 2-20GHz 12dB Gain SMA Female



LB-20200-SFSP0 Broadband Horn Antenna 2-20GHz 12dB Gain SMA Female



LB-20200-NF Broadband Horn Antenna 2-20GHz 12dB Gain N Type Female



LB-20200-NFP Broadband Horn Antenna 2-20GHz 12dB Gain N Type Female



LB-20200-NFSPO Broadband Horn Antenna 2-20GHz 12dB Gain N Type Female



LB-20200-NFSPS Broadband Horn Antenna 2-20GHz 12dB Gain N Type Female



LB-20200H-SF Broadband Horn Antenna 2-20GHz 17dB Gain SMA Female



LB-20200H-SFSPPO Broadband Horn Antenna 2-20GHz 17dB Gain SMA Female



LB-20200H-NF Broadband Horn Antenna 2-20GHz 17dB Gain N Type Female



LB-20200H-NFSPO Broadband Horn Antenna 2-20GHz 17dB Gain N Type Female



LB-SJ-20180-SF Broadband Dual Polarization Horn Antenna 2-18GHz 14dB Gain SMA Female



LB-SJ-20180-SFSPPO Broadband Dual Polarization Horn Antenna 2-18GHz 14dB Gain SMA Female



LB-SJ-20180-SFSPS Broadband Dual Polarization Horn Antenna 2-18GHz 14dB Gain SMA Female



LB-SJ-20180-NF Broadband Dual Polarization Horn Antenna 2-18GHz 14dB Gain N Type Female



LB-SJ-20180-NFSPO Broadband Dual Polarization Horn Antenna 2-18GHz 14dB Gain N Type Female



LB-OSJ-20180-SF Open Boundary Quad-Ridged Dual Polarization Horn Antenna 2-18GHz 13dB Gain SMA Female

About this Datasheet

- Product Information

Product Link:
<https://www.ainfoinc.com/lb-20180h-nfspo-broadband-horn-antenna-2-18-ghz-17db-gain-n-type-female>
 Data subject to change without notice.
 © A-INFO INC. 2024. All Rights Reserved

- Contact Us

Address:
 60 Tesla, Irvine, CA 92618,
 USA

Website:
www.ainfoinc.com

Email:
sales@ainfoinc.com

- Phone & Fax

Phone:
 +1-949-639-9688
 +1-949-639-9608

Fax:
 +1-949-639-9670