

LB-SJ-10100-NF Broadband Dual Polarization Horn Antenna 1-10GHz
10dB Gain N Type Female

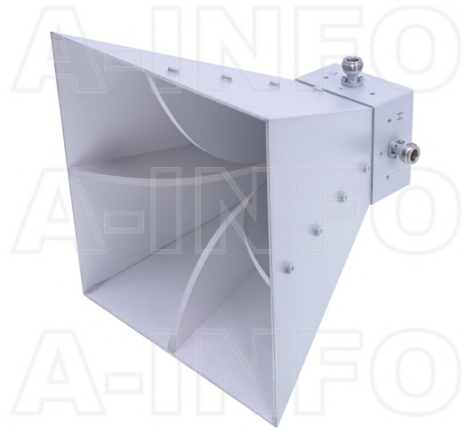

Broadband Dual Polarization Horn Antenna Operating From 1GHz to 10GHz With a Nominal 10dB Gain With N Type Female Connector

Product Information

SKU	LB-SJ-10100-NF
-----	----------------

Description

Broadband Dual Polarization Horn Antenna LB-SJ-10100-NF, operating from 1 to 10GHz with a nominal 10dB gain and low VSWR 1.5:1 with N Type Female output connector. The model LB-SJ-10100-NF has uniform gain through its frequency span, providing efficient performance characteristics and directionality. It can handle 50W continuously and 100W peak power. Constructed of lightweight corrosion-resistant aluminum, the antenna will provide years of trouble-free indoor and outdoor service. This horn antenna has dual linear polarization and ideally suited for EMI testing, direction finding, surveillance, antenna gain and pattern measurements and other applications.

Technical Specification

Electrical Specification		Interface	
Frequency, Min (GHz)	1	Output Type	Coaxial
Frequency, Max (GHz)	10	Connector	N Type
Gain, Typ (dBi)	10	Connector Gender	Female
Polarization	Dual Linear	Mechanical Specification	
3dB Beamwidth, E-Plane, Min (Deg.)	19	Body Material	Al
3dB Beamwidth, E-Plane, Max (Deg.)	69	Finish	Chemical Conversion Coating, Gray Paint
3dB Beamwidth, H-Plane, Min (Deg.)	22	Size, W (mm)	204
3dB Beamwidth, H-Plane, Max (Deg.)	72	Size, H (mm)	204
Cross Pol. Isolation, Min (dB)	18	Size, L (mm)	211
Cross Pol. Isolation, Typ (dB)	30	Weight, (kg)	1.7
Port to Port Isolation, Min (dB)	20		
Port to Port Isolation, Typ (dB)	30		
VSWR, Typ	1.5:1		
Impedance, (Ohm)	50		
Power Handling, CW, (W)	50		
Power Handling, Peak, (W)	100		

Additional Information

Application	General Purpose Indoor & Outdoor, Fixed	Solution for	Antenna Measurement Reflector Feed Far-field Measurement Planar Near-Field Measurement Cylindrical Near-Field Measurement Spherical Near-Field Measurement CATR System Intergration
-------------	---	--------------	--

Outline Drawing

N-Female Output (P/N: LB-SJ-10100-NF)

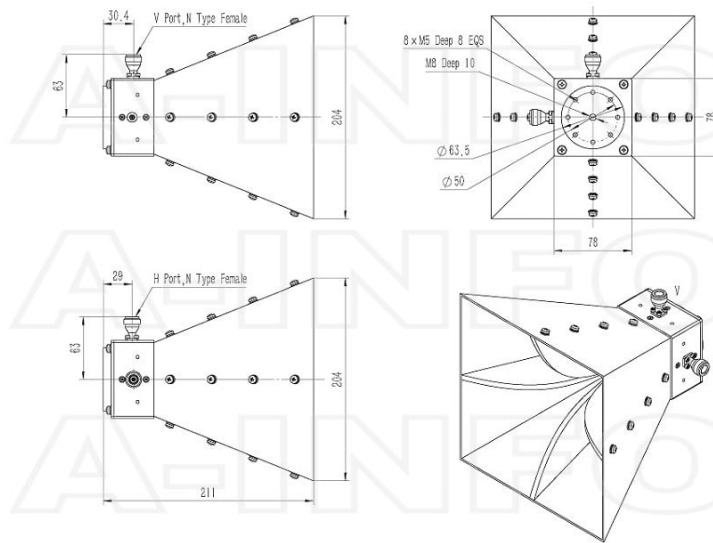

N-Female Output with L Type Mounting Bracket (Option, P/N: LB-10180-L)

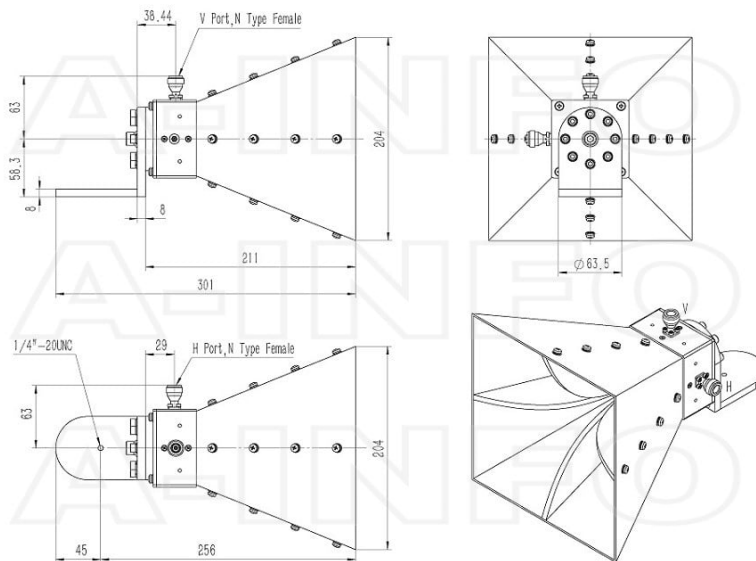

Typical Test Results

Gain

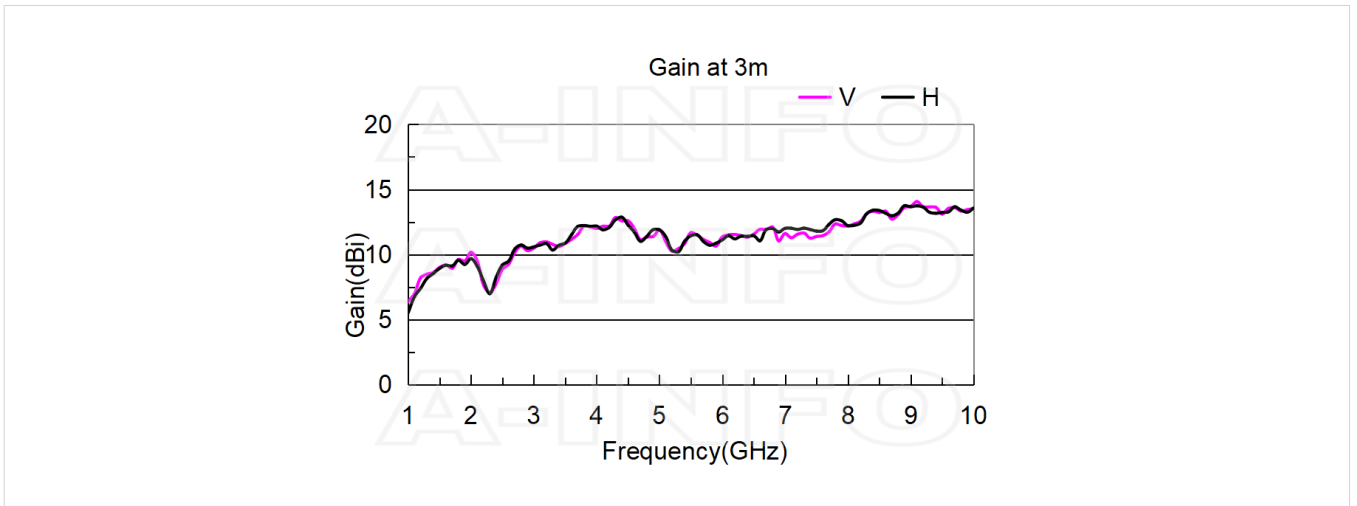
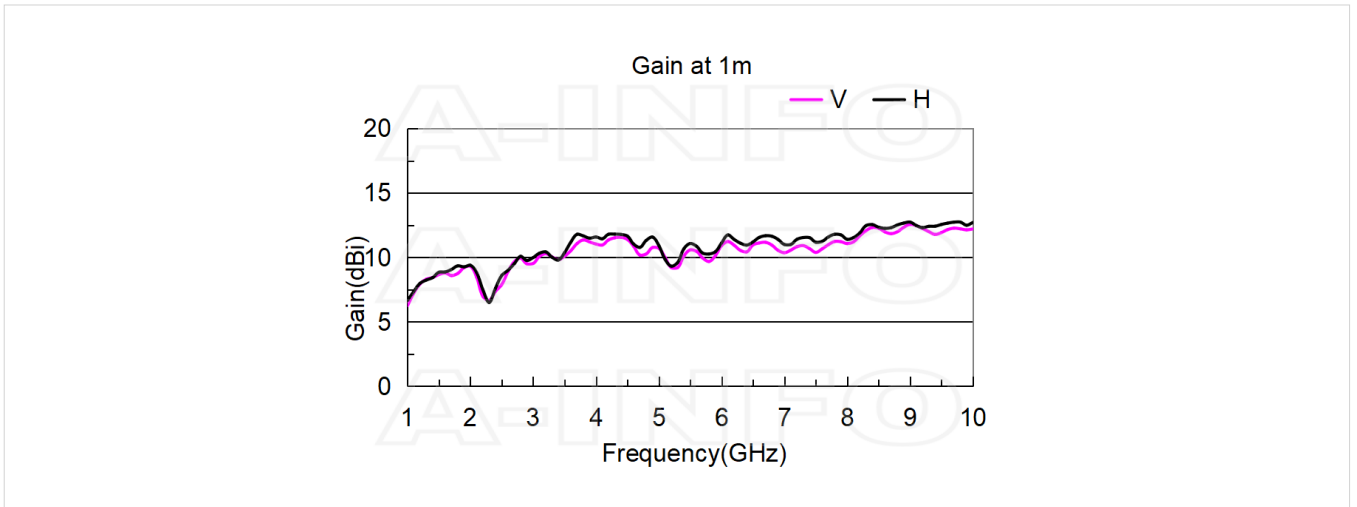

Antenna Factor

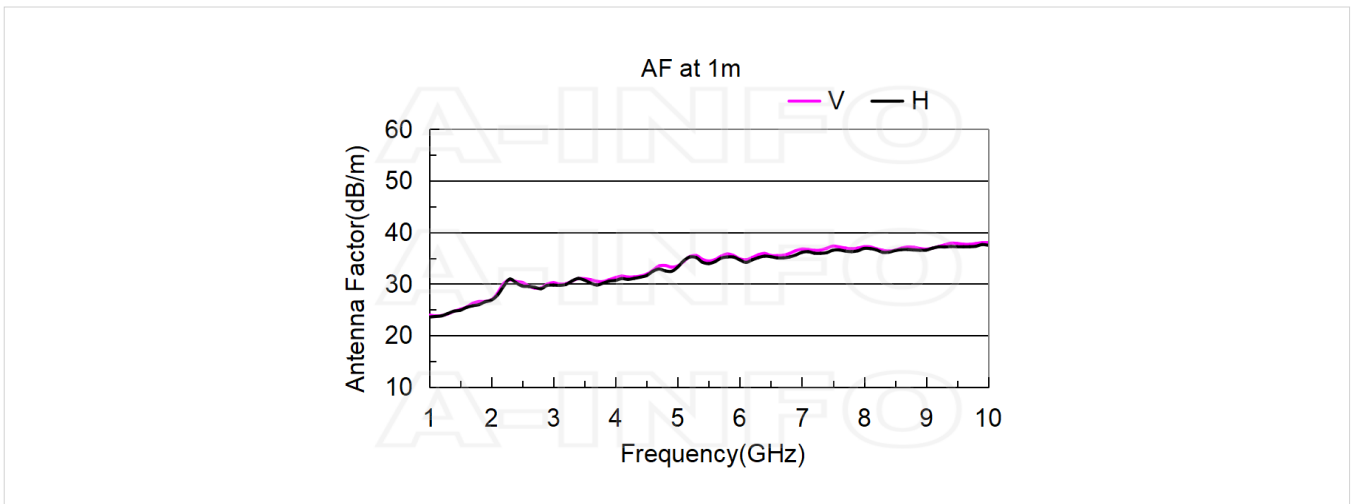

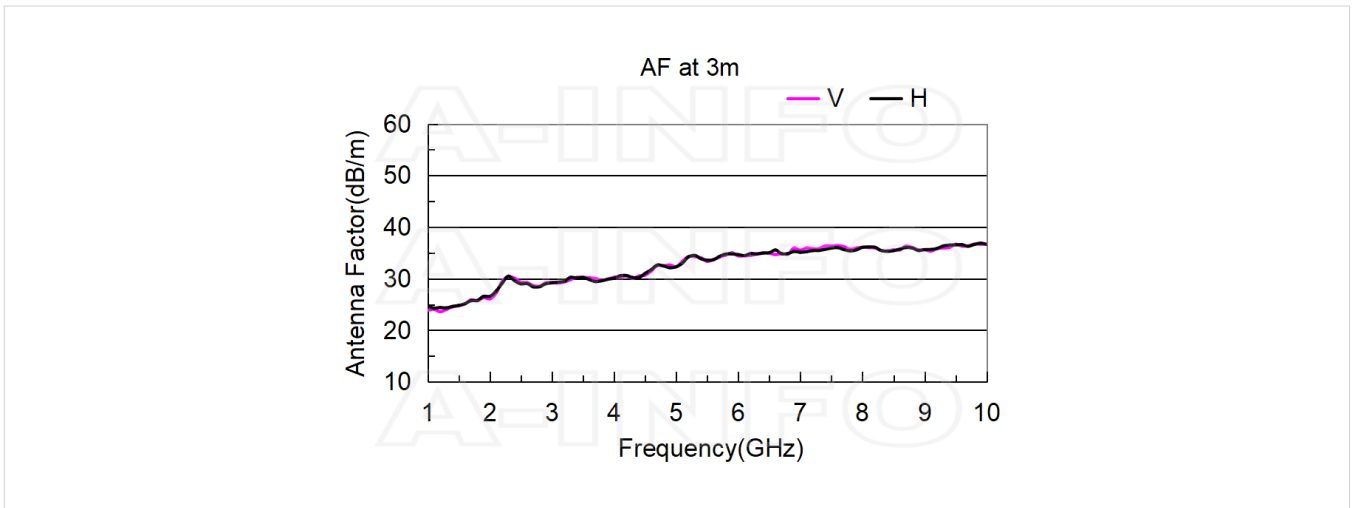

Antenna Factor (Table)

1m

Frequency(GHz)	Horizontal		Vertical	
	Gain(dBi)	AF(dB/m)	Gain(dBi)	AF(dB/m)
1.0	6.65	23.56	6.26	23.95
2.0	9.39	26.84	9.32	26.91
3.0	9.98	29.77	9.53	30.23
4.0	11.58	30.67	11.03	31.22
5.0	10.93	33.26	10.71	33.48
6.0	11.12	34.65	10.91	34.87
7.0	11.00	36.11	10.36	36.75
8.0	11.40	36.87	11.07	37.20
9.0	12.74	36.56	12.55	36.74
10.0	12.71	37.50	12.20	38.01

3m

Frequency(GHz)	Horizontal		Vertical	
	Gain(dBi)	AF(dB/m)	Gain(dBi)	AF(dB/m)
1.0	5.51	24.70	6.37	23.84
2.0	9.67	26.56	10.16	26.07
3.0	10.58	29.18	10.48	29.27
4.0	12.17	30.08	12.00	30.25
5.0	11.89	32.30	11.89	32.30
6.0	11.11	34.66	11.34	34.43
7.0	12.00	35.11	11.60	35.51
8.0	12.21	36.06	12.19	36.09
9.0	13.67	35.63	13.70	35.59
10.0	13.56	36.65	13.54	36.67

Cross Polarization Isolation

Port-H

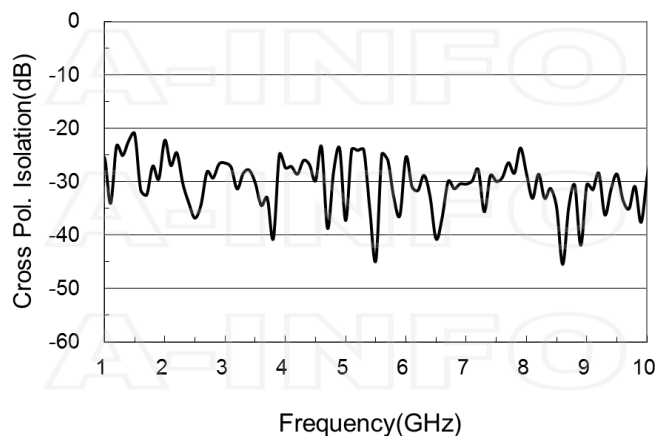

Port-V

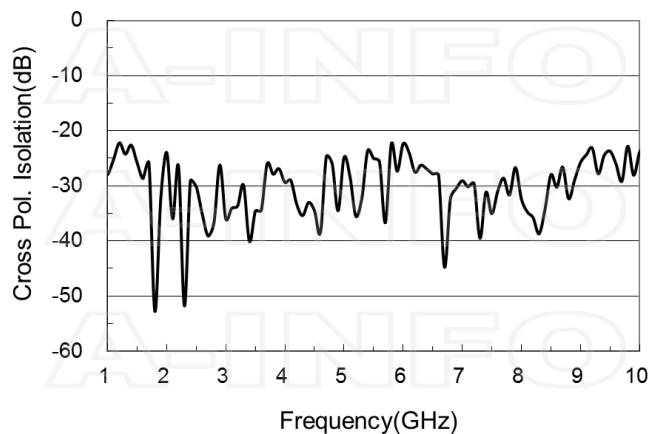

Port to Port Isolation

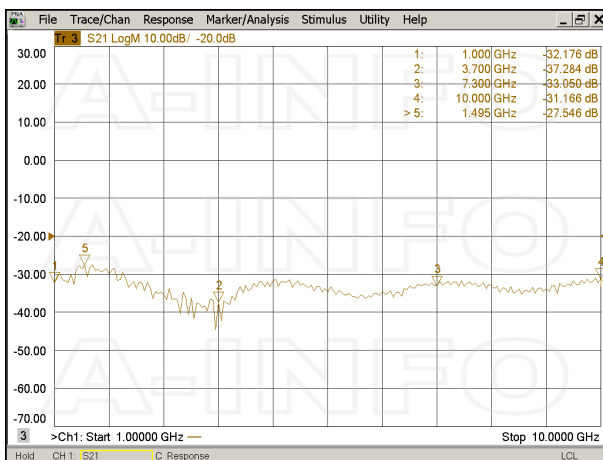

VSWR

Port-H

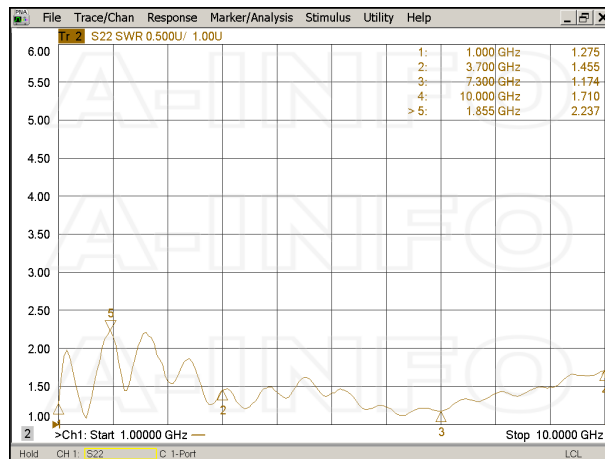

Port-V

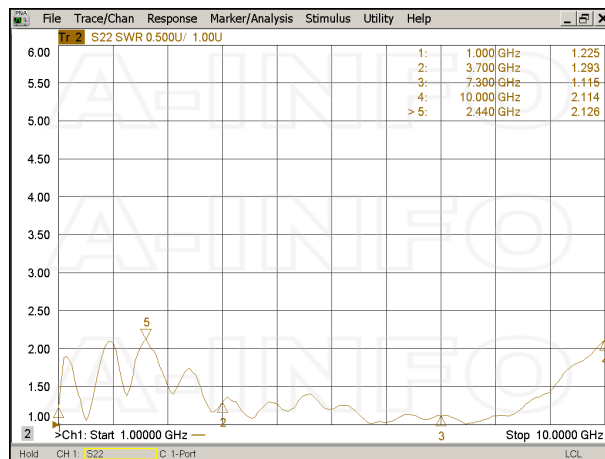

Beamwidth

3dB Beamwidth

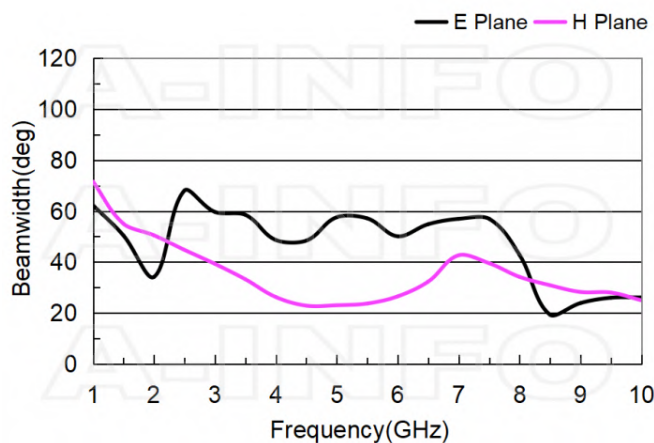

10dB Beamwidth

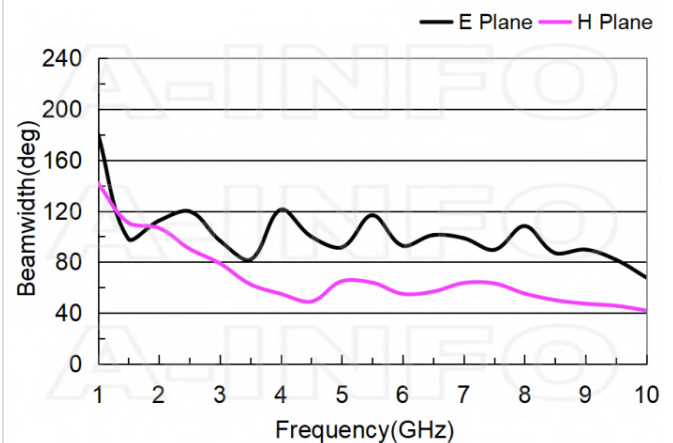

Pattern 2



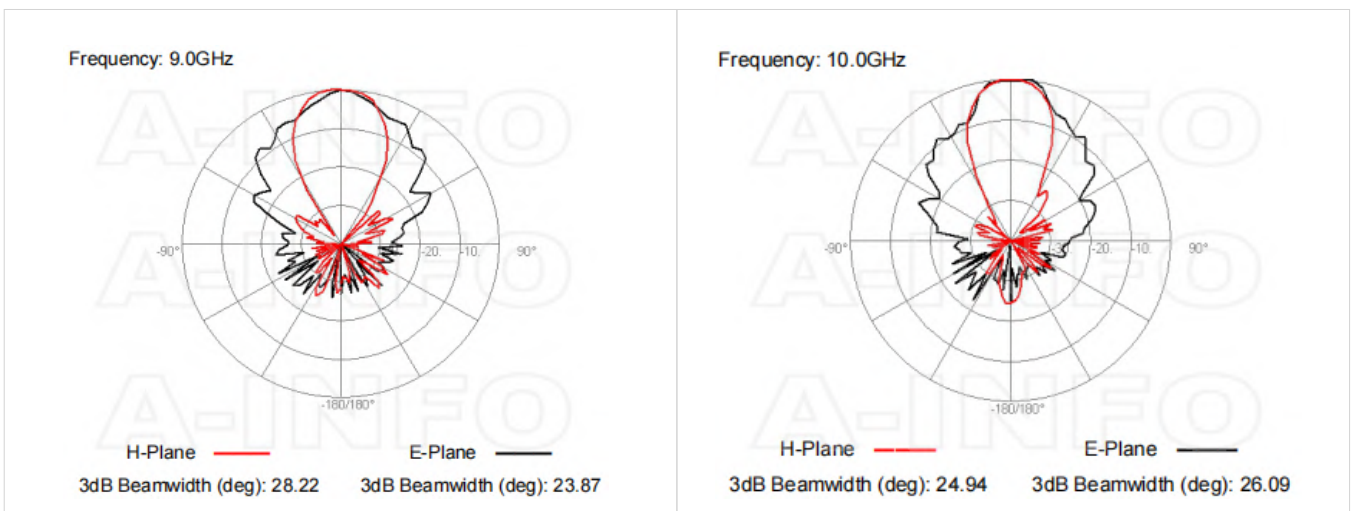
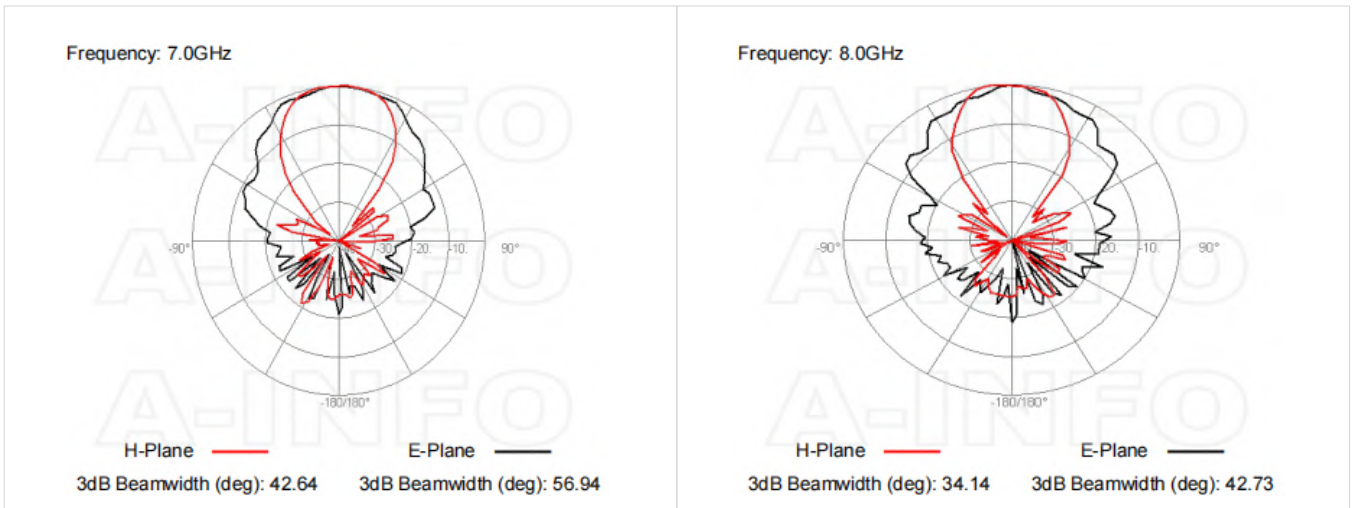

Related Products



LB-10180-L L type mounting bracket



LB-10180-MA Stinger Type Mounting Bracket



Tripod_15Kg Al Alloy Tripod



3033HL Wooden Tripod



3033QM Wooden Tripod Metalfree



Carrying Case_LB-SJ-10100 Al Alloy Carrying Case



NM-NM-A050-1000 Flexible Cable Assembly 1000mm DC-18GHz N Male to N Male



NM-NM-A050-1500 Flexible Cable Assembly 1500mm DC-18GHz N Male to N Male



NM-NM-A050-2000 Flexible Cable Assembly 2000mm DC-18GHz N Male to N Male



NM-NM-A050-3000 Flexible Cable Assembly 3000mm DC-18GHz N Male to N Male



NM-NM-A050-5000 Flexible Cable Assembly 5000mm DC-18GHz N Male to N Male



NM-NM-A050-10000 Flexible Cable Assembly 10000mm DC-18GHz N Male to N Male



NM-NM-A050-20000 Flexible Cable Assembly 20000mm DC-18GHz N Male to N Male



NM-NM-A100-1000 Flexible Cable Assembly 1000mm DC-18GHz N Male to N Male



NM-NM-A100-1500 Flexible Cable Assembly 1500mm DC-18GHz N Male to N Male



NM-NM-A100-2000 Flexible Cable Assembly 2000mm DC-18GHz N Male to N Male



NM-NM-A100-3000 Flexible Cable Assembly 3000mm DC-18GHz N Male to N Male



NM-NM-A100-5000 Flexible Cable Assembly 5000mm DC-18GHz N Male to N Male



NM-NM-A100-10000 Flexible Cable Assembly 10000mm DC-18GHz N Male to N Male



NM-NM-A100-20000 Flexible Cable Assembly 20000mm DC-18GHz N Male to N Male

About this Datasheet

<ul style="list-style-type: none"> ● Product Information Product Link: https://www.ainfoinc.com/lb-sj-10100-nf-broadband-dual-polarization-horn-antenna-1-10-ghz-10db-gain-n-type-female Data subject to change without notice. © A-INFO INC. 2024. All Rights Reserved 	<ul style="list-style-type: none"> ● Contact Us Address: 60 Tesla, Irvine, CA 92618, USA Website: www.ainfoinc.com Email: sales@ainfoinc.com 	<ul style="list-style-type: none"> ● Phone & Fax Phone: +1-949-639-9688 +1-949-639-9608 Fax: +1-949-639-9670
---	--	---