

LB-20200-SF Broadband Horn Antenna 2-20GHz 12dB Gain SMA Female



Broadband Horn Antenna Operating From 2GHz to 20GHz With a Nominal 12dB Gain With SMA Female Connector

Product Information

SKU	LB-20200-SF
-----	-------------

Description

Broadband horn antenna LB-20200-SF, operating from 2 to 20GHz with a nominal 12dB gain and low VSWR 1.5:1 with SMA Female output connector. The model LB-20200-SF has uniform gain through its frequency span, providing efficient performance characteristics and directionality. It can handle 50W continuously and 100W peak power. Constructed of lightweight corrosion-resistant aluminum, the antenna will provide years of trouble-free indoor and outdoor service. This broadband horn antenna is linearly polarized and ideally suited for EMI testing, direction finding, surveillance, antenna gain and pattern measurements and other applications.

Also we provide specific gain horn antennas according to customers' requirement.

Technical Specification

Electrical Specification		Interface	
Frequency, Min (GHz)	2	Output Type	Coaxial
Frequency, Max (GHz)	20	Connector	SMA
Gain, Typ (dBi)	12	Connector Gender	Female
Polarization	Linear	Mechanical Specification	
3dB Beamwidth, E-Plane, Min (Deg.)	16	Body Material	Al
3dB Beamwidth, E-Plane, Max (Deg.)	85	Finish	Chemical Conversion Coating
3dB Beamwidth, H-Plane, Min (Deg.)	18	Size, W (mm)	103.8
3dB Beamwidth, H-Plane, Max (Deg.)	77	Size, H (mm)	77.9
Cross Pol. Isolation, Typ (dB)	25	Size, L (mm)	127
VSWR, Typ	1.5:1	Weight, (kg)	0.4
Impedance, (Ohm)	50		
Power Handling, CW, (W)	50		
Power Handling, Peak, (W)	100		

Additional Information

Application	General Purpose Indoor & Outdoor, Fixed	Solution for	Gain Reference Antenna Measurement Reflector Feed Far-field Measurement System Intergration
-------------	---	--------------	---

Outline Drawing

SMA-Female Output (P/N: LB-2020-SF)

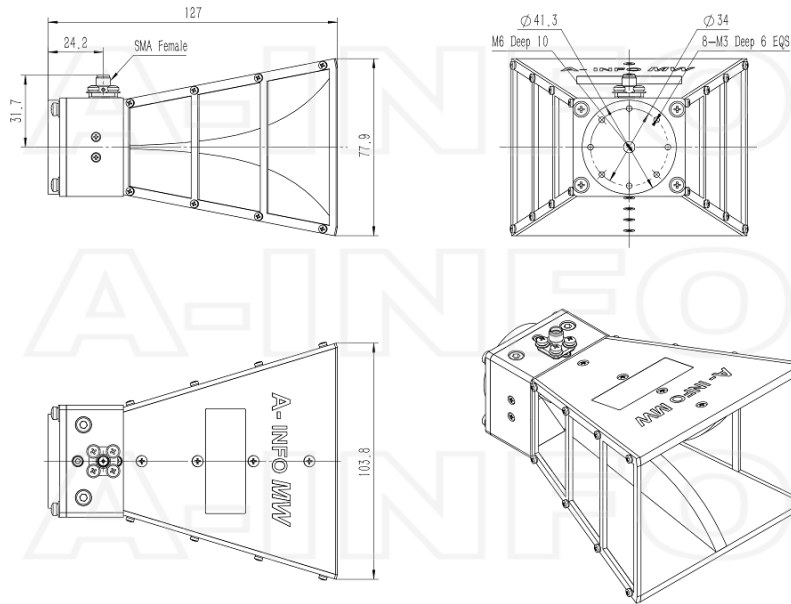

SMA-Female Output with L Type Mounting Bracket (Option, P/N: LB-20180-L)

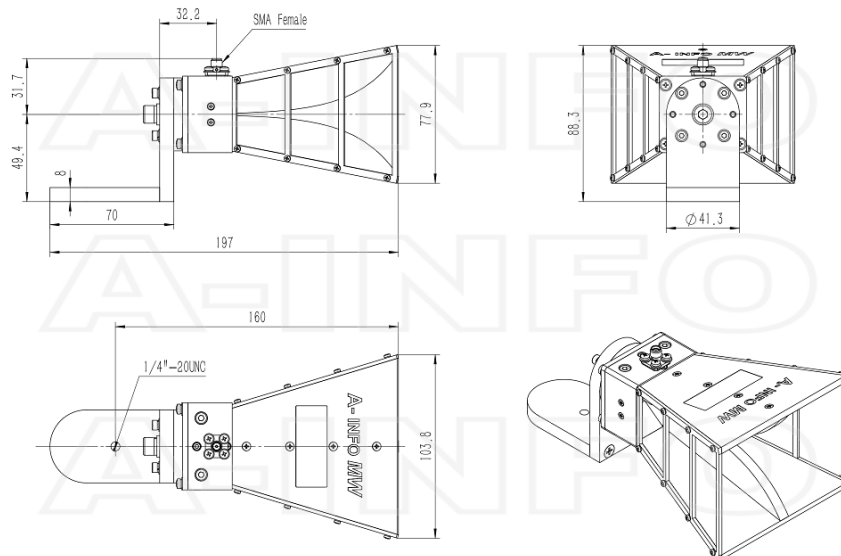

Typical Test Results

Gain

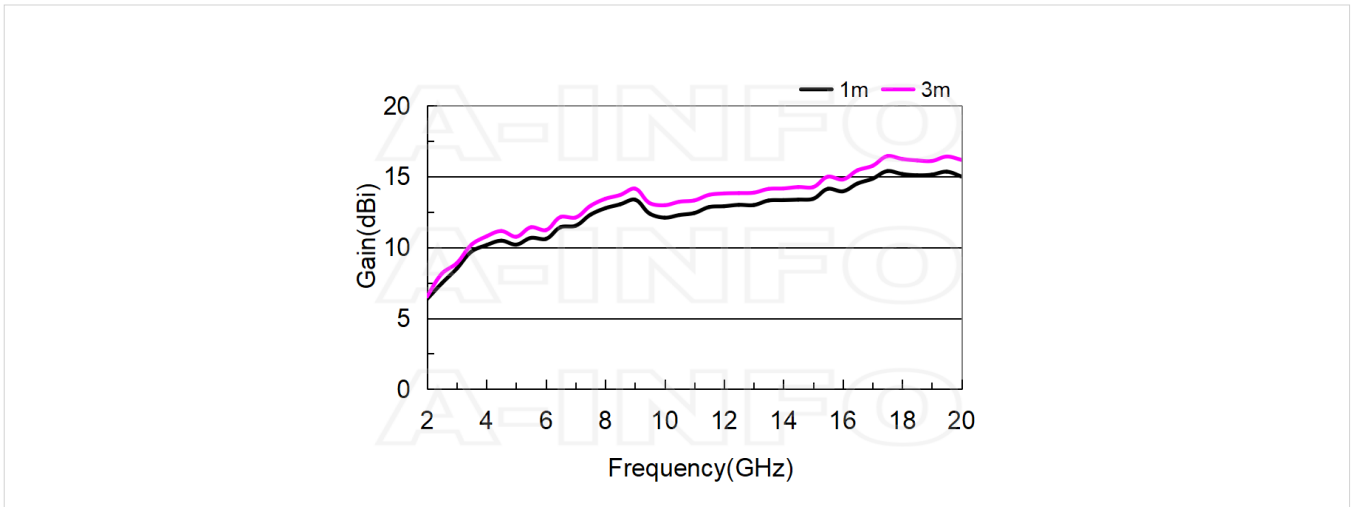

Antenna Factor

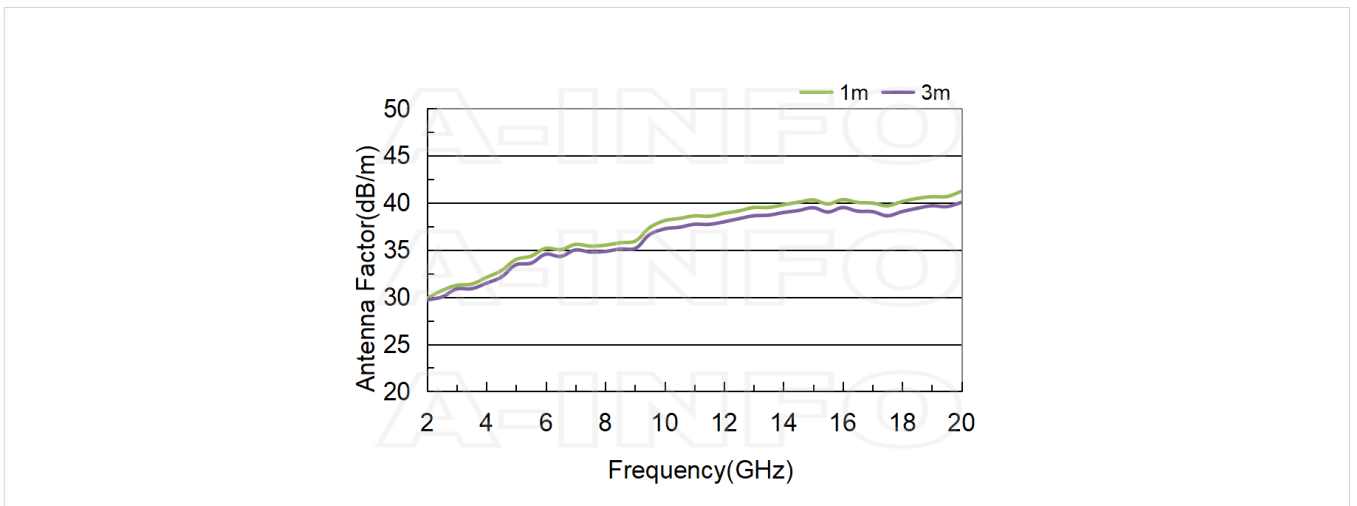

Antenna Factor (Table)

Frequency(GHz)	1m		3m	
	Gain(dBi)	AF(dB/m)	Gain(dBi)	AF(dB/m)
2.0	6.36	29.87	6.53	29.70
3.0	8.50	31.25	8.89	30.86
4.0	10.16	32.09	10.78	31.47
5.0	10.20	33.99	10.75	33.44
6.0	10.60	35.17	11.22	34.55
7.0	11.53	35.59	12.11	35.00
8.0	12.76	35.51	13.43	34.84
9.0	13.37	35.92	14.15	35.15
10.0	12.10	38.11	12.98	37.23
12.0	12.91	38.89	13.81	37.99
14.0	13.34	39.79	14.16	38.97
16.0	13.96	40.33	14.79	39.50
18.0	15.18	40.14	16.24	39.07
20.0	15.00	41.23	16.18	40.05

Field Strength

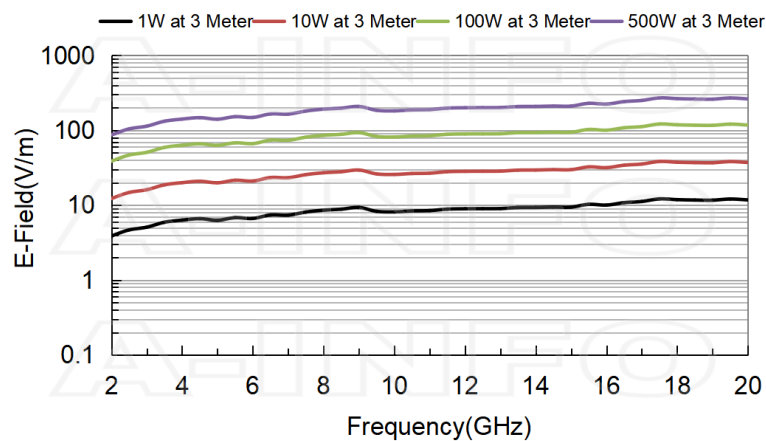
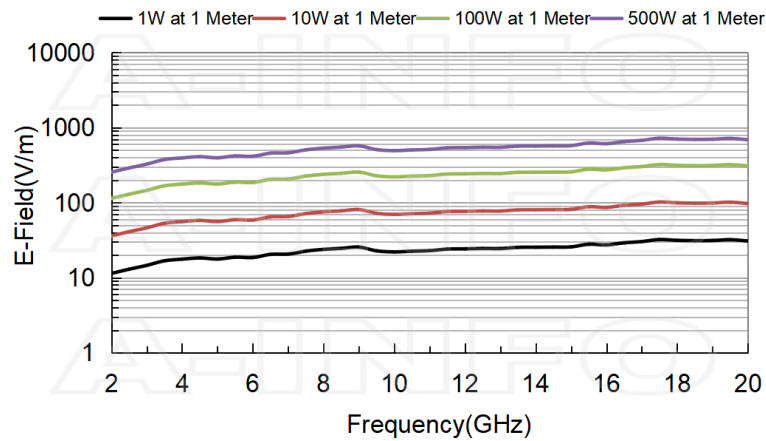

Cross Polarization Isolation

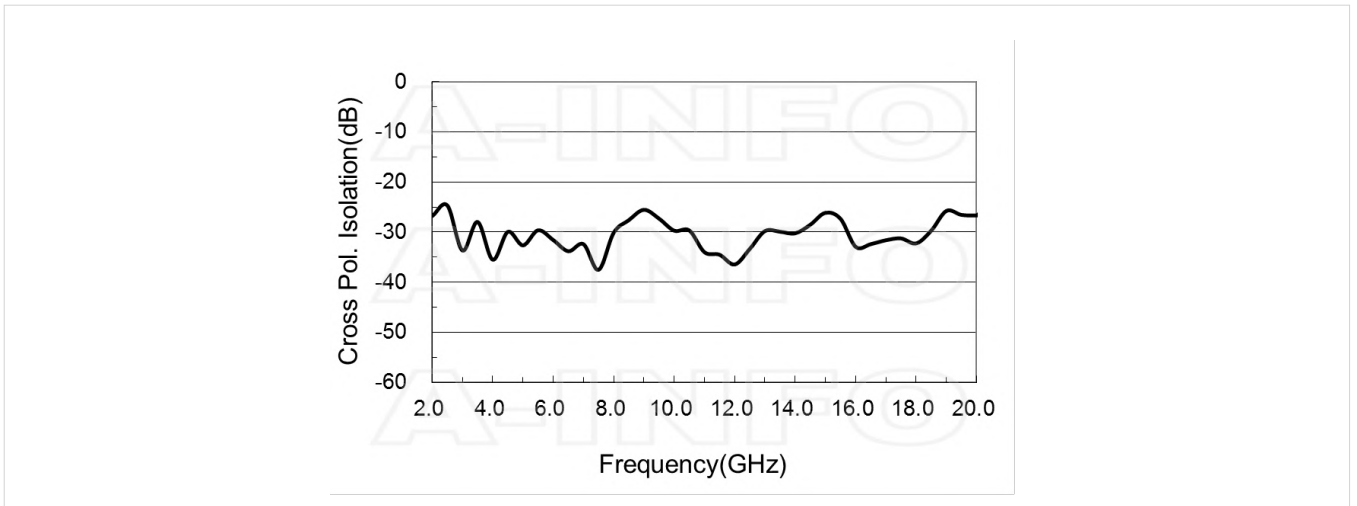

VSWR

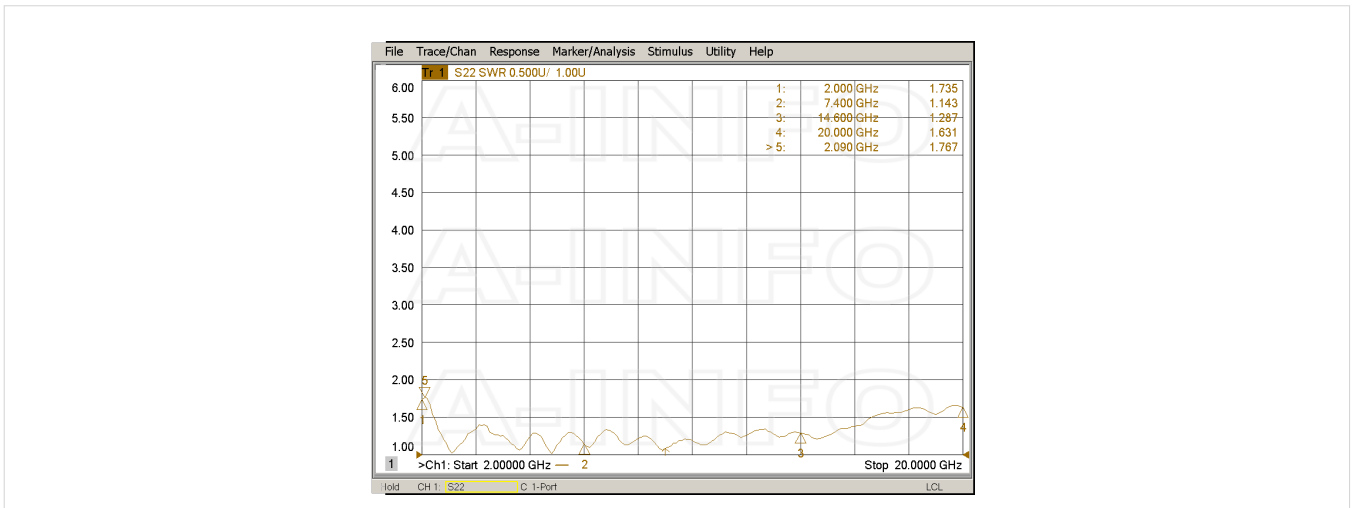

Beamwidth

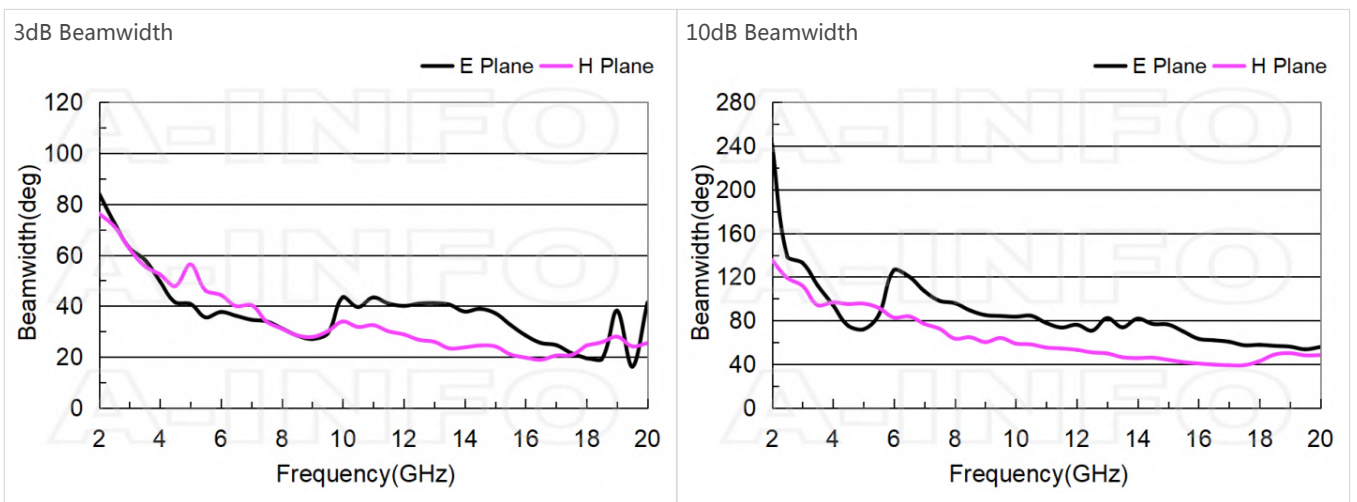

Pattern



Frequency:8.000GHz

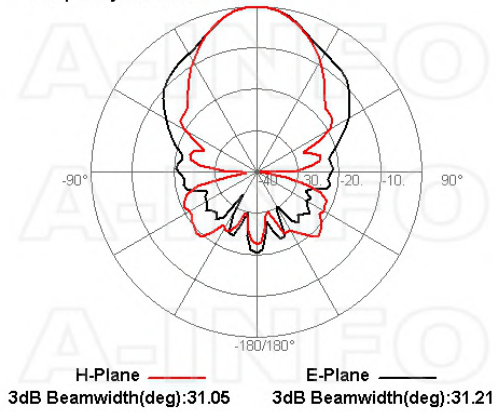

Frequency:9.000GHz

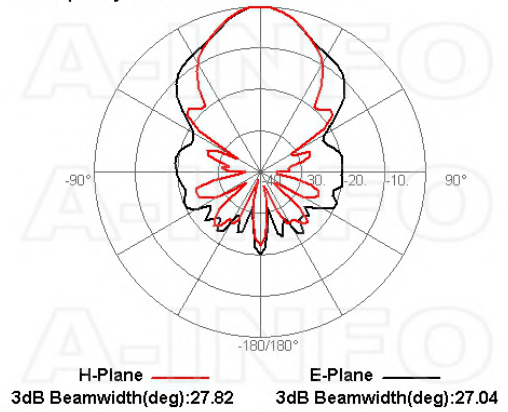

Frequency:10.000GHz

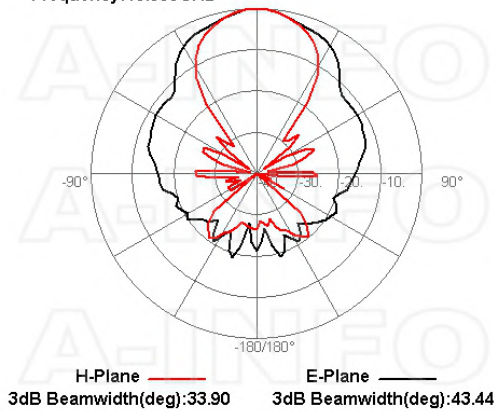

Frequency:12.000GHz

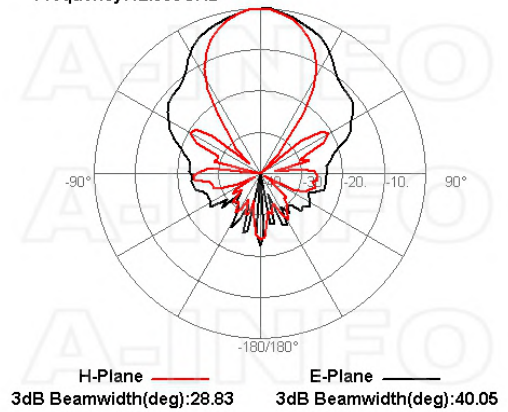

Frequency:14.000GHz

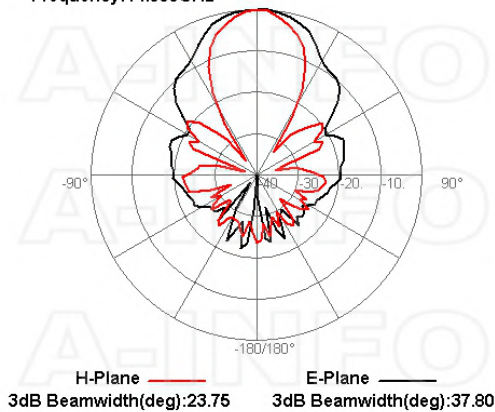

Frequency:16.000GHz

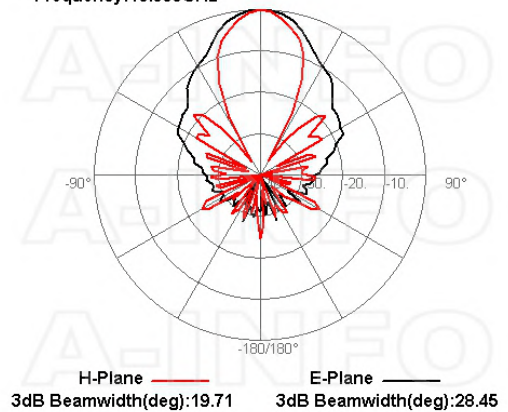

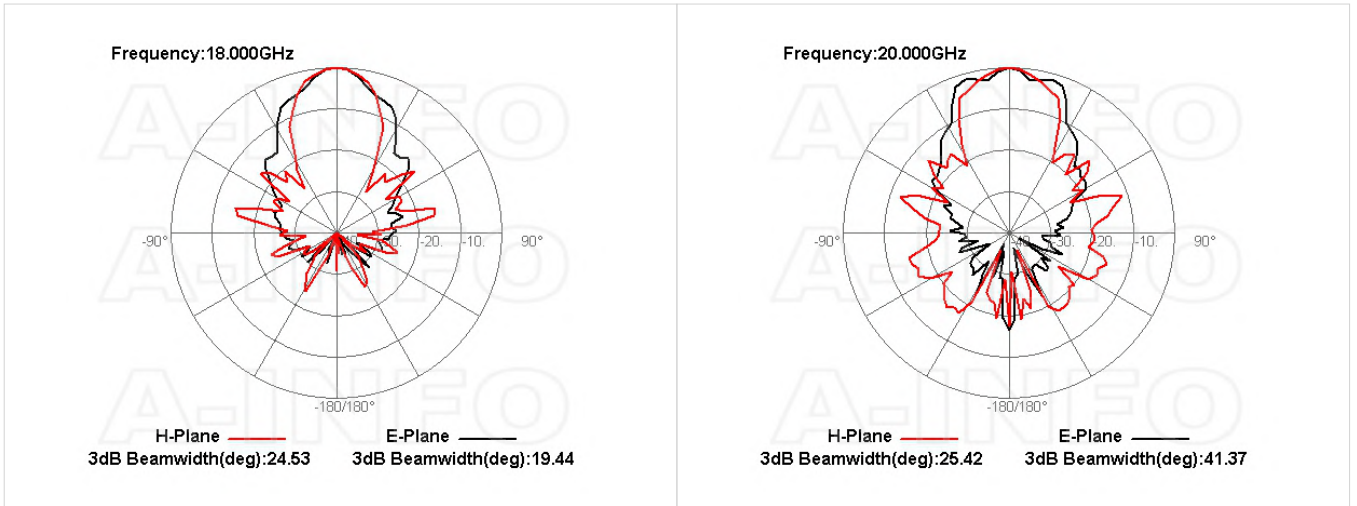

Related Products



LB-20180-L L Type Mounting Bracket



Tripod_15Kg Al Alloy Tripod



3033HL Wooden Tripod



3033QM Wooden Tripod Metalfree



Carrying Case_LB-20180 Al Alloy Carrying Case



SM-SM-A050-500 Flexible Cable Assembly 500mm DC- 26.5GHz SMA Male to SMA Male



SM-SM-A050-1000 Flexible Cable Assembly 1000mm DC- 26.5GHz SMA Male to SMA Male



SM-SM-A050-1500 Flexible Cable Assembly 1500mm DC- 26.5GHz SMA Male to SMA Male



SM-SM-A050-2000 Flexible Cable Assembly 2000mm DC- 26.5GHz SMA Male to SMA Male



SM-SM-A050-3000 Flexible Cable Assembly 3000mm DC- 26.5GHz SMA Male to SMA Male



SM-SM-A050-5000 Flexible Cable Assembly 5000mm DC- 26.5GHz SMA Male to SMA Male



SM-SM-A050-10000 Flexible Cable Assembly 10000mm DC- 26.5GHz SMA Male to SMA Male



SM-SM-A080-200 Flexible Cable Assembly 200mm DC- 26.5GHz SMA Male to SMA Male



SM-SM-A080-300 Flexible Cable Assembly 300mm DC- 26.5GHz SMA Male to SMA Male



SM-SM-A080-500 Flexible Cable Assembly 500mm DC- 26.5GHz SMA Male to SMA Male



SM-SM-A080-1000 Flexible Cable Assembly 1000mm DC- 26.5GHz SMA Male to SMA Male



SM-SM-A080-1500 Flexible Cable Assembly 1500mm DC- 26.5GHz SMA Male to SMA Male



SM-SM-A080-2000 Flexible Cable Assembly 2000mm DC- 26.5GHz SMA Male to SMA Male



SM-SM-A080-3000 Flexible Cable Assembly 3000mm DC- 26.5GHz SMA Male to SMA Male



SM-SM-A080-5000 Flexible Cable Assembly 5000mm DC- 26.5GHz SMA Male to SMA Male



SM-SM-A080-10000 Flexible Cable Assembly 10000mm DC- 26.5GHz SMA Male to SMA Male



SM-SM-A080-20000 Flexible Cable Assembly 20000mm DC- 26.5GHz SMA Male to SMA Male

Similar Products



LB-2080-SF Broadband Horn Antenna 2-8GHz 12dB Gain SMA Female



LB-2080-SFP Broadband Horn Antenna 2-8GHz 12dB Gain SMA Female



LB-2080-SFSPO Broadband Horn Antenna 2-8GHz 12dB Gain SMA Female



LB-2080-NF Broadband Horn Antenna 2-8GHz 12dB Gain N Type Female



LB-2080-NFP Broadband Horn Antenna 2-8GHz 12dB Gain N Type Female



LB-2080-NFSPO Broadband Horn Antenna 2-8GHz 12dB Gain N Type Female



LB-20180-SF Broadband Horn Antenna 2-18GHz 12dB Gain SMA Female



LB-20180-SFP Broadband Horn Antenna 2-18GHz 12dB Gain SMA Female



LB-20180-SFSP0 Broadband Horn Antenna 2-18GHz 12dB Gain SMA Female



LB-20180-NF Broadband Horn Antenna 2-18GHz 12dB Gain N Type Female



LB-20180-NFP Broadband Horn Antenna 2-18GHz 12dB Gain N Type Female



LB-20180-NFSPO Broadband Horn Antenna 2-18GHz 12dB Gain N Type Female



LB-20180-NFSPS Broadband Horn Antenna 2-18GHz 12dB Gain N Type Female



LB-20180H-SF Broadband Horn Antenna 2-18GHz 17dB Gain SMA Female



LB-20180H-SFSP0 Broadband Horn Antenna 2-18GHz 17dB Gain SMA Female



LB-20180H-SFSPS Broadband Horn Antenna 2-18GHz 17dB Gain SMA Female



LB-20180H-NF Broadband Horn Antenna 2-18GHz 17dB Gain N Type Female



LB-20180H-NFSPO Broadband Horn Antenna 2-18GHz 17dB Gain N Type Female



LB-20200-SFP Broadband Horn Antenna 2-20GHz 12dB Gain SMA Female



LB-20200-SFSP0 Broadband Horn Antenna 2-20GHz 12dB Gain SMA Female



LB-20200-NF Broadband Horn Antenna 2-20GHz 12dB Gain N Type Female



LB-20200-NFP Broadband Horn Antenna 2-20GHz 12dB Gain N Type Female



LB-20200-NFSP0 Broadband Horn Antenna 2-20GHz 12dB Gain N Type Female



LB-20200-NFSPS Broadband Horn Antenna 2-20GHz 12dB Gain N Type Female



LB-20200H-SF Broadband Horn Antenna 2-20GHz 17dB Gain SMA Female



LB-20200H-SFSP0 Broadband Horn Antenna 2-20GHz 17dB Gain SMA Female



LB-20200H-NF Broadband Horn Antenna 2-20GHz 17dB Gain N Type Female



LB-20200H-NFSP0 Broadband Horn Antenna 2-20GHz 17dB Gain N Type Female



LB-SJ-20180-SF Broadband Dual Polarization Horn Antenna 2-18GHz 14dB Gain SMA Female



LB-SJ-20180-SFSP0 Broadband Dual Polarization Horn Antenna 2-18GHz 14dB Gain SMA Female



LB-SJ-20180-SFSPS Broadband Dual Polarization Horn Antenna 2-18GHz 14dB Gain SMA Female



LB-SJ-20180-NF Broadband Dual Polarization Horn Antenna 2-18GHz 14dB Gain N Type Female



LB-SJ-20180-NFSP0 Broadband Dual Polarization Horn Antenna 2-18GHz 14dB Gain N Type Female



LB-OSJ-20180-SF Open Boundary Quad-Ridged Dual Polarization Horn Antenna 2-18GHz 13dB Gain SMA Female

About this Datasheet

<ul style="list-style-type: none">● Product Information <p>Product Link: https://www.ainfoinc.com/lb-2020-sf-broadband-horn-antenna-2-20-ghz-12db-gain-sma-female Data subject to change without notice. © A-INFO INC. 2024. All Rights Reserved</p>	<ul style="list-style-type: none">● Contact Us <p>Address: 60 Tesla, Irvine, CA 92618, USA</p> <p>Website: www.ainfoinc.com</p> <p>Email: sales@ainfoinc.com</p>	<ul style="list-style-type: none">● Phone & Fax <p>Phone: +1-949-639-9688 +1-949-639-9608</p> <p>Fax: +1-949-639-9670</p>
--	---	--