



LB-180500-2.4F Broadband Horn Antenna 18-50GHz 15dB Gain 2.4mm Female

Broadband Horn Antenna Operating From 18GHz to 50GHz With a Nominal 15dB Gain With 2.4mm Female Connector

### Product Information

SKU	LB-180500-2.4F
-----	----------------

### Description

Broadband horn antenna LB-180500-2.4F, operating from 18 to 50GHz with a nominal 15dB gain and low VSWR 2.0:1 with 2.4mm Female output connector. The model LB-180500-2.4F has uniform gain through its frequency span, providing efficient performance characteristics and directionality. It can handle 10W continuously and 20W peak power. Constructed of lightweight corrosion-resistant aluminum, the antenna will provide years of trouble-free indoor and outdoor service. This broadband horn antenna is linearly polarized and ideally suited for EMI testing, direction finding, surveillance, antenna gain and pattern measurements and other applications.

Also we provide specific gain horn antennas according to customers' requirement.

### Technical Specification

Electrical Specification		Interface	
Frequency, Min (GHz)	18	Output Type	Coaxial
Frequency, Max (GHz)	50	Connector	2.4mm
Gain, Typ (dBi)	15	Connector Gender	Female
Polarization	Linear	Mechanical Specification	
3dB Beamwidth, E-Plane, Min (Deg.)	18	Body Material	Cu
3dB Beamwidth, E-Plane, Max (Deg.)	51	Finish	Gold Plated, Gray Paint
3dB Beamwidth, H-Plane, Min (Deg.)	13	Size, W (mm)	32
3dB Beamwidth, H-Plane, Max (Deg.)	53	Size, H (mm)	29.9
Cross Pol. Isolation, Typ (dB)	40	Size, L (mm)	71
VSWR, Typ	1.5:1	Weight, (kg)	0.1
Impedance, (Ohm)	50		
Power Handling, CW, (W)	10		
Power Handling, Peak, (W)	20		

## Additional Information

Application	General Purpose Indoor & Outdoor, Fixed	Solution for	Gain Reference Antenna Measurement Reflector Feed Far-field Measurement System Intergration
-------------	---	--------------	---

## Outline Drawing

2.4mm-Female Output (P/N: LB-180500-2.4F)

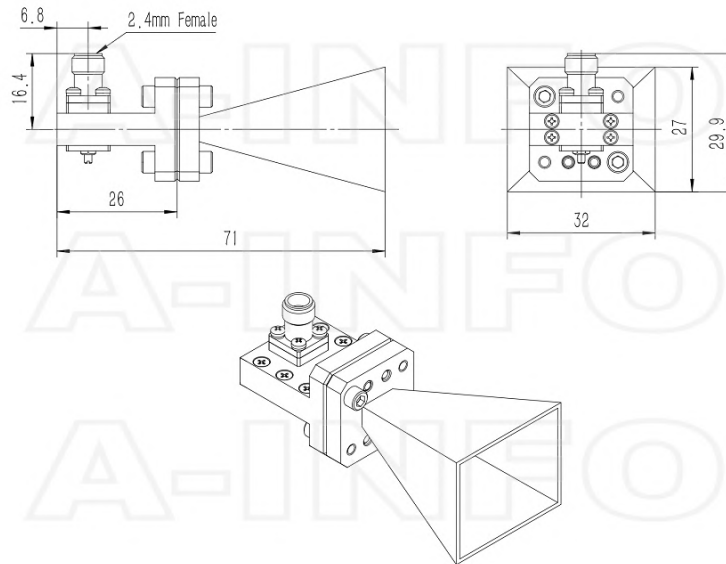

2.4mm-Female Output with Round Mounting Bracket (Option, P/N: LB-180400-10-C-MB)

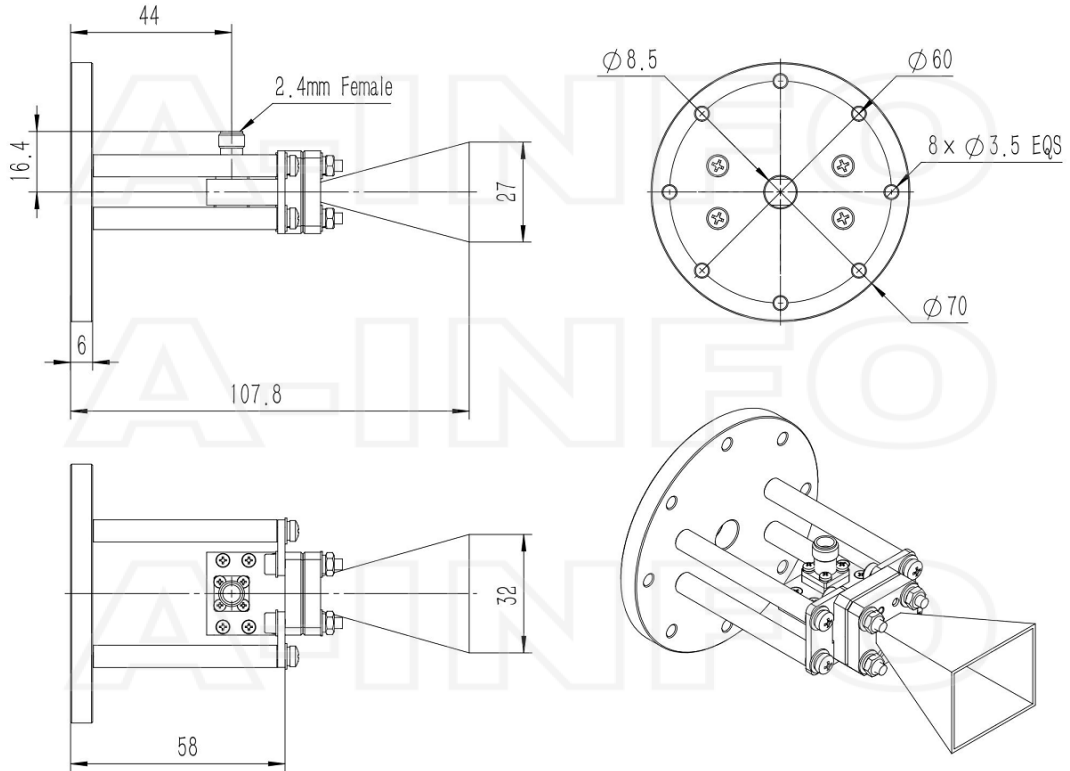

2.4mm-Female Output with L Type Mounting Bracket (Option, P/N: LB-180400-10-C-MBL)

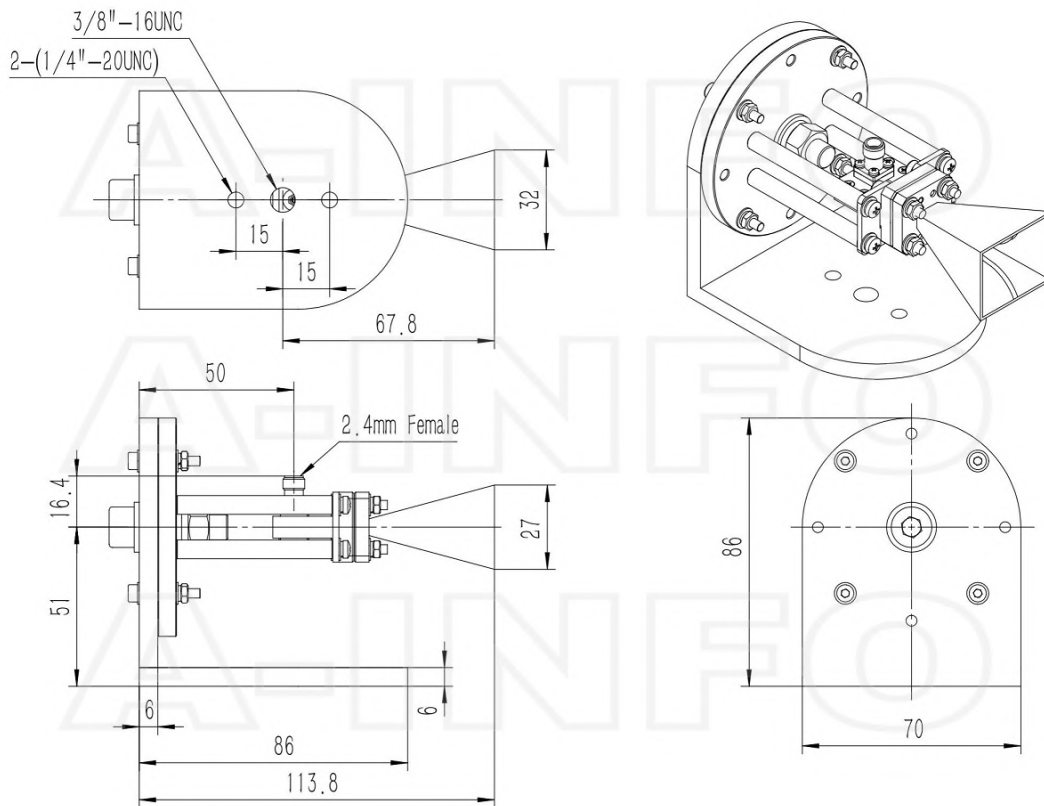

## Typical Test Results

### Gain

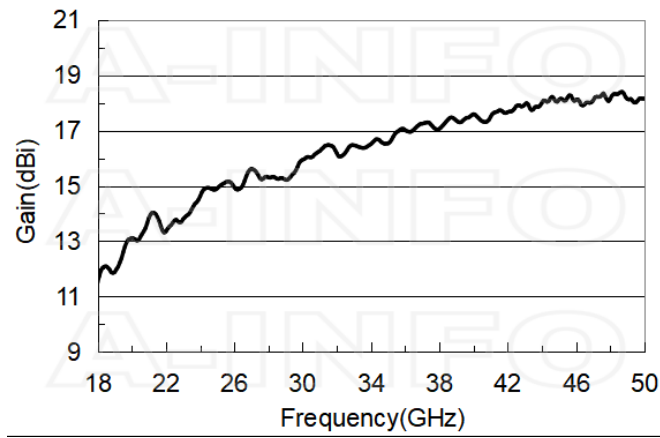

### Antenna Factor

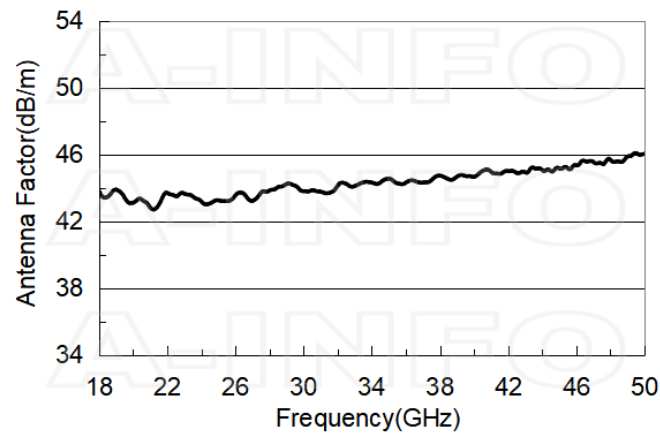

### Antenna Factor (Table)

Frequency(GHz)	Gain(dBi )	Antenna Factor(dB/m)
18.0	11.51	43.80
20.0	13.12	43.11
22.0	13.35	43.70
24.0	14.62	43.19
26.0	14.95	43.56
28.0	15.30	43.85
30.0	15.94	43.81
32.0	16.18	44.13
34.0	16.51	44.33
36.0	17.02	44.32
38.0	17.06	44.74
40.0	17.59	44.66
42.0	17.67	45.01
44.0	18.00	45.08
46.0	18.11	45.35
48.0	18.14	45.69
50.0	18.15	46.04
52.0	17.72	46.81

### Cross Polarization Isolation

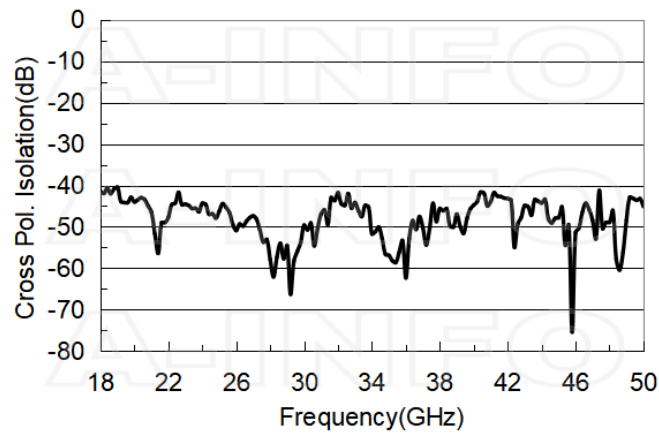

## VSWR

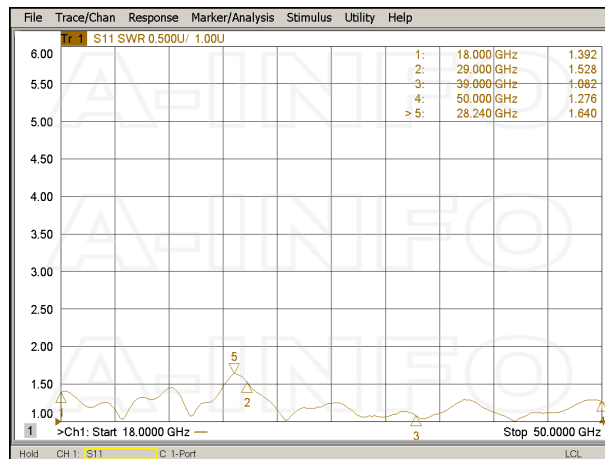

## Beamwidth

3dB Beamwidth

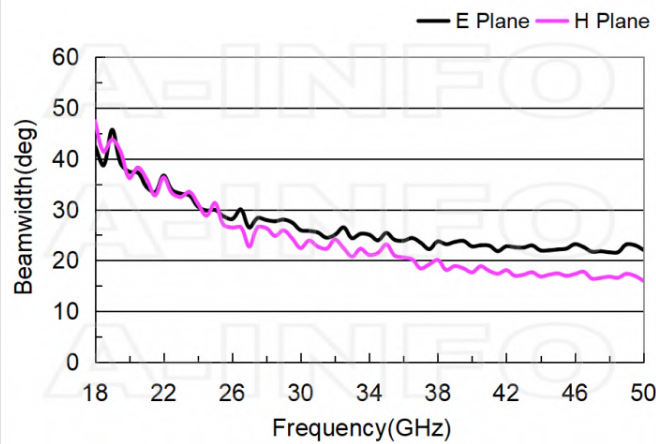

10dB Beamwidth

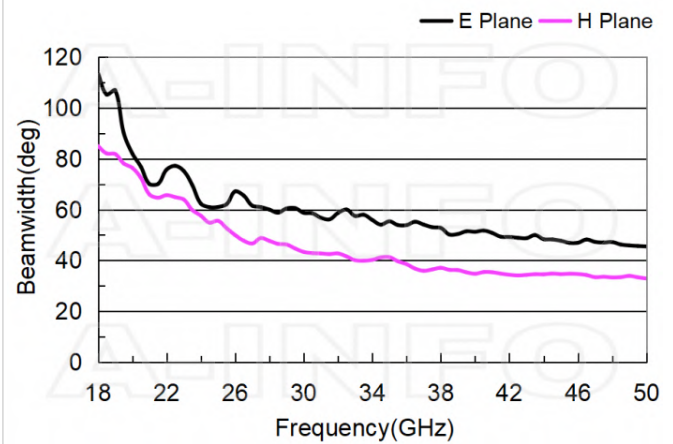

## Pattern

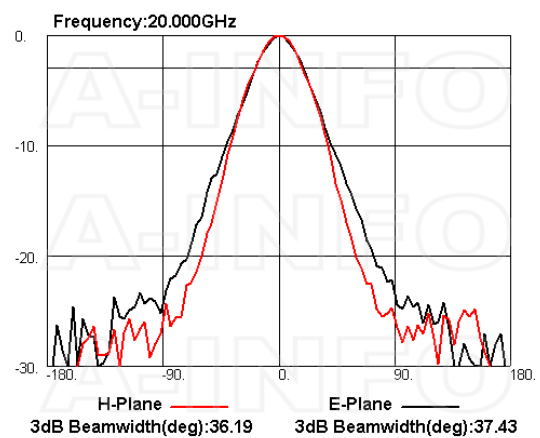
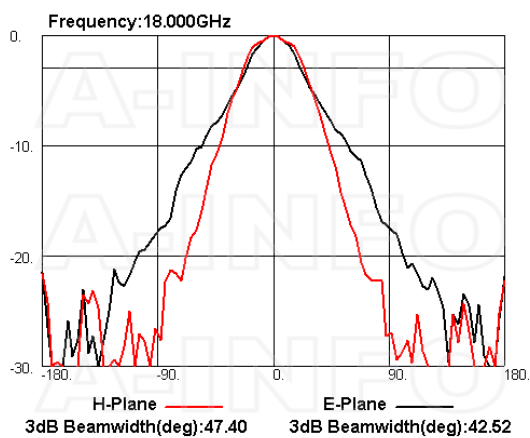

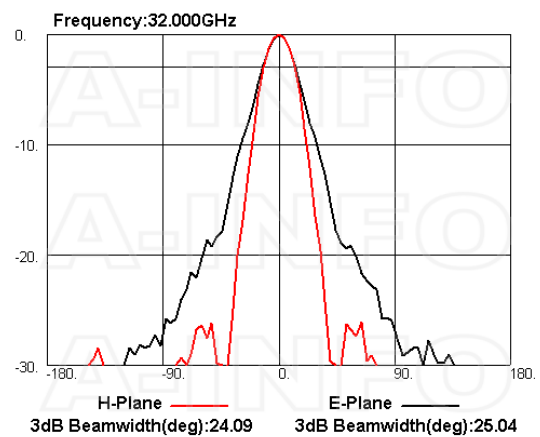
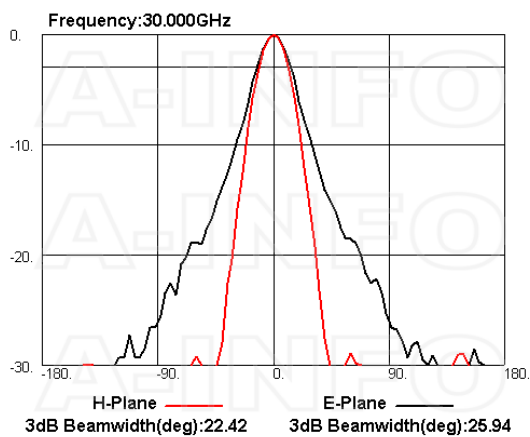
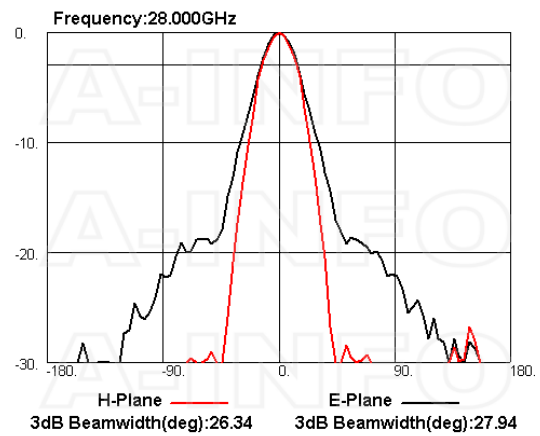
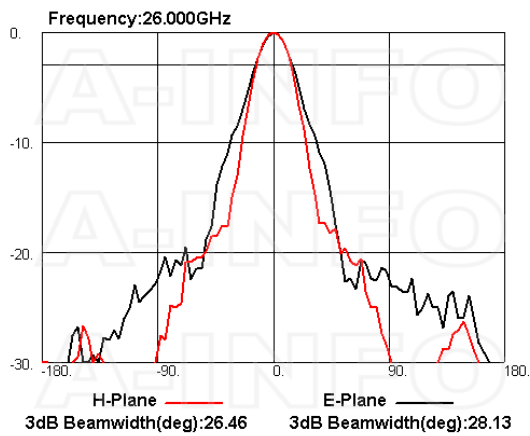
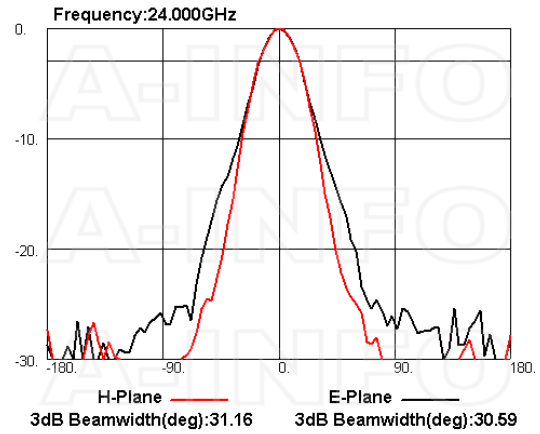
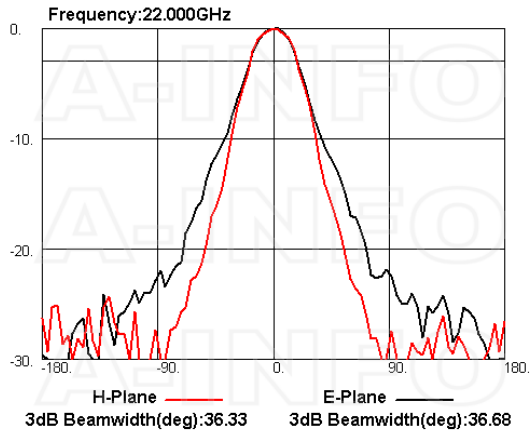

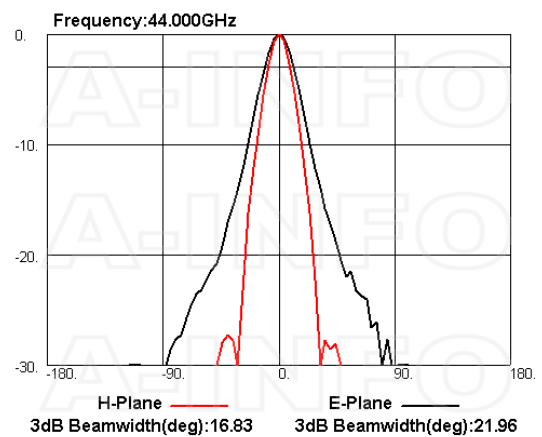
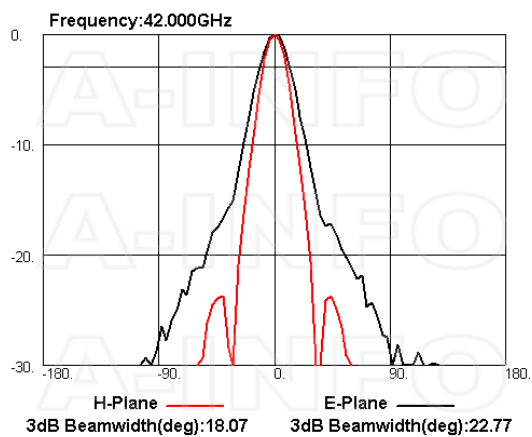
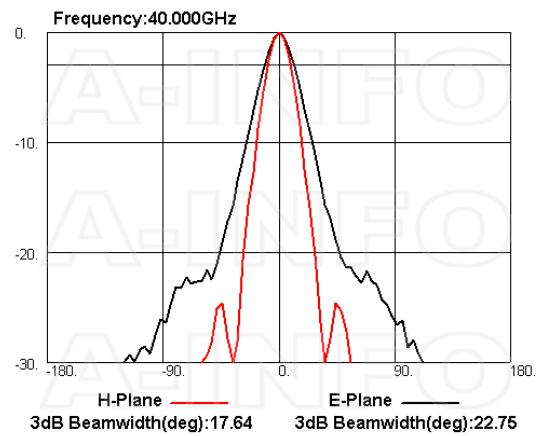
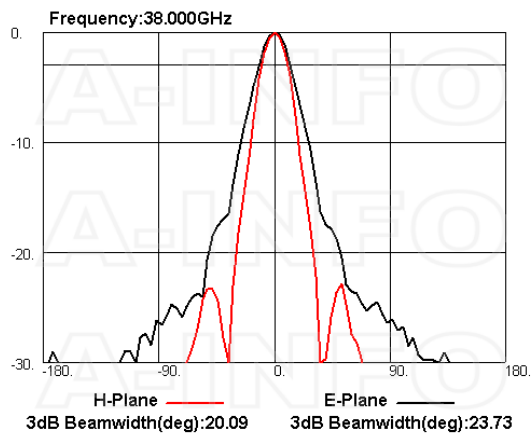
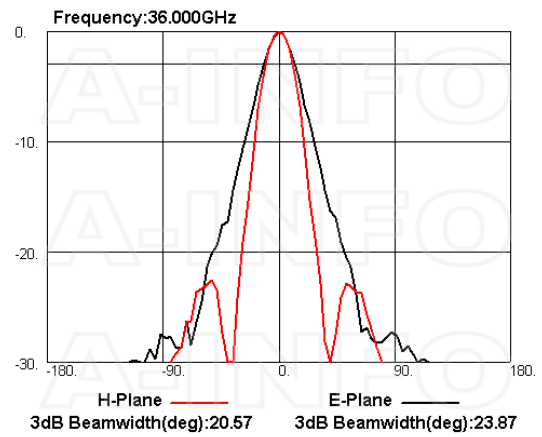
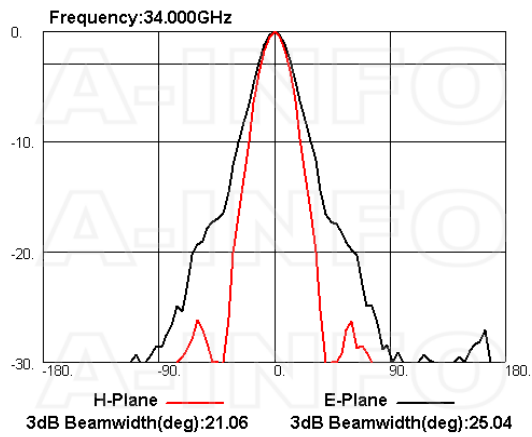

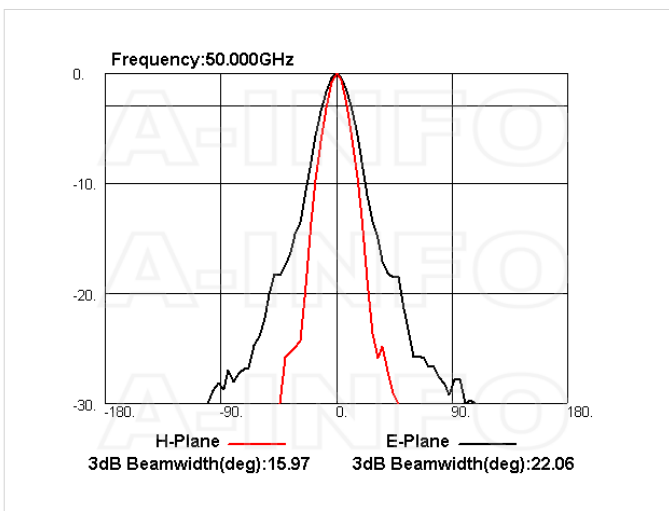
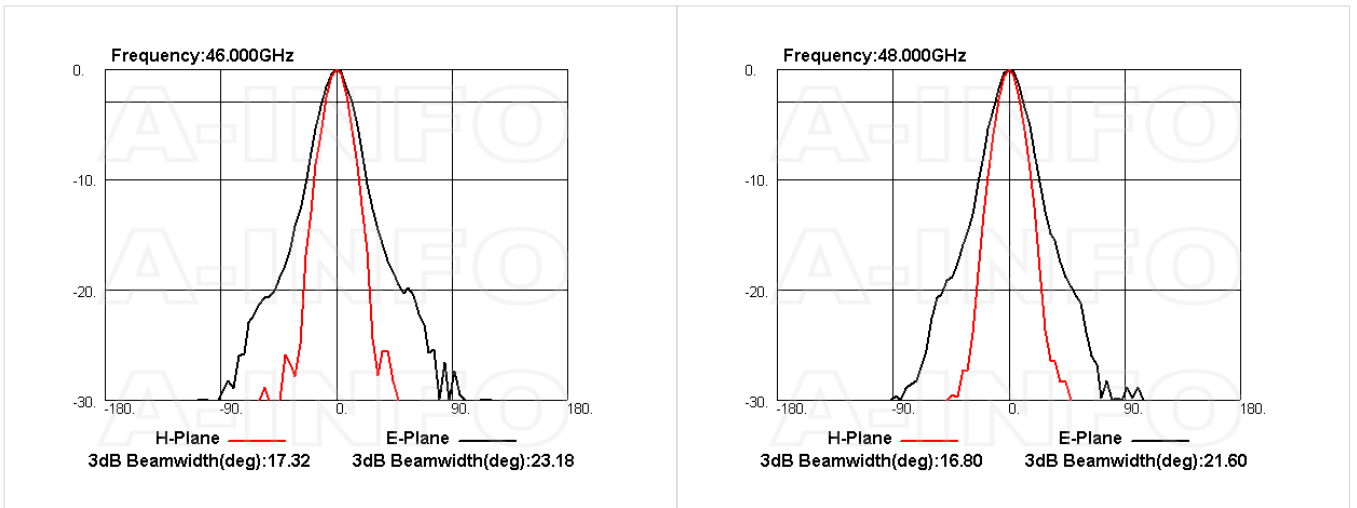

## Related Products



LB-180400-10-C-MB Round Type Mounting Bracket



LB-180400-10-C-MBL L Type Mounting Bracket



Tripod\_15Kg Al Alloy Tripod



3033HL Wooden Tripod



3033QM Wooden Tripod  
Metalfree



Carrying Case\_LB-180400-15 Al  
Alloy Carrying Case



2.4M-2.4M-B020-500 Flexible  
Cable Assembly 500mm DC-  
50GHz 2.4mm Male to 2.4mm  
Male



2.4M-2.4M-B020-1000 Flexible  
Cable Assembly 1000mm DC-  
50GHz 2.4mm Male to 2.4mm  
Male



2.4M-2.4M-B020-1500 Flexible  
Cable Assembly 1500mm DC-  
50GHz 2.4mm Male to 2.4mm  
Male



2.4M-2.4M-B020-2000 Flexible  
Cable Assembly 2000mm DC-  
50GHz 2.4mm Male to 2.4mm  
Male



2.4M-2.4M-B020-3000 Flexible  
Cable Assembly 3000mm DC-  
50GHz 2.4mm Male to 2.4mm  
Male



2.4M-2.4M-B020-5000 Flexible  
Cable Assembly 5000mm DC-  
50GHz 2.4mm Male to 2.4mm  
Male



2.4M-2.4M-B020-10000 Flexible  
Cable Assembly 10000mm DC-  
50GHz 2.4mm Male to 2.4mm  
Male



2.4M-2.4F-B020S-500 Flexible  
Cable Assembly 500mm DC-  
50GHz 2.4mm Male to 2.4mm  
Female



2.4M-2.4F-B020S-1000 Flexible  
Cable Assembly 1000mm DC-  
50GHz 2.4mm Male to 2.4mm  
Female



2.4M-2.4F-B020S-1500 Flexible  
Cable Assembly 1500mm DC-  
50GHz 2.4mm Male to 2.4mm  
Female



2.4M-2.4F-B020S-2000 Flexible  
Cable Assembly 2000mm DC-  
50GHz 2.4mm Male to 2.4mm  
Female



2.4M-2.4F-B020S-3000 Flexible  
Cable Assembly 3000mm DC-  
50GHz 2.4mm Male to 2.4mm  
Female



2.4M-2.4F-B020S-5000 Flexible  
Cable Assembly 5000mm DC-  
50GHz 2.4mm Male to 2.4mm  
Female



2.4M-2.4F-B020S-10000 Flexible  
Cable Assembly 10000mm DC-  
50GHz 2.4mm Male to 2.4mm  
Female

### Similar Products



LB-180400-KF Broadband Horn Antenna 18-40GHz 15dB Gain 2.92mm Female



LB-180400-KM Broadband Horn Antenna 18-40GHz 15dB Gain 2.92mm Male

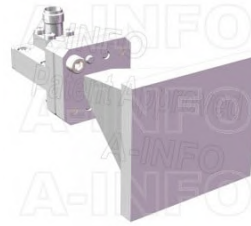

LB-180400-KFSPO Broadband Horn Antenna 18-40GHz 15dB Gain 2.92mm Female



LB-180400-2.4F Broadband Horn Antenna 18-40GHz 15dB Gain 2.4mm Female

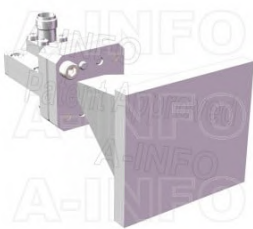

LB-180400-2.4FSPO Broadband Horn Antenna 18-40GHz 15dB Gain 2.4mm Female



LB-180400H-KF Broadband Horn Antenna 18-40GHz 20dB Gain 2.92mm Female



LB-180400H-KM Broadband Horn Antenna 18-40GHz 20dB Gain 2.92mm Male



LB-180400H-KFSPO Broadband Horn Antenna 18-40GHz 20dB Gain 2.92mm Female



LB-180400H-2.4F Broadband Horn Antenna 18-40GHz 20dB Gain 2.4mm Female



LB-180400H-2.4FSPO Broadband Horn Antenna 18-40GHz 20dB Gain 2.4mm Female

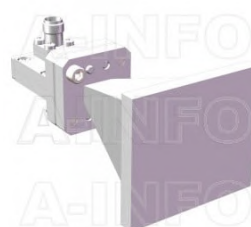

LB-180500-2.4FSPO Broadband Horn Antenna 18-50GHz 15dB Gain 2.4mm Female



LB-180500H-2.4F Broadband Horn Antenna 18-50GHz 20dB Gain 2.4mm Female



LB-180500H-2.4FSPO Broadband Horn Antenna 18-50GHz 20dB Gain 2.4mm Female



LB-60670-1.85F Broadband Horn Antenna 6-67GHz 13dB Gain 1.85mm Female



LB-60670-1.85FSPO Broadband Horn Antenna 6-67GHz 13dB Gain 1.85mm Female



LB-SJ-40400-KF Broadband Dual Polarization Horn Antenna 4-40GHz 12dB Gain 2.92mm Female



LB-SJ-40400-KFSPO Broadband  
Dual Polarization Horn Antenna  
4-40GHz 12dB Gain 2.92mm  
Female



LB-SJ-40400-2.4F Broadband  
Dual Polarization Horn Antenna  
4-40GHz 12dB Gain 2.4mm  
Female



LB-SJ-40400-2.4FSPO Broadband  
Dual Polarization Horn Antenna  
4-40GHz 12dB Gain 2.4mm  
Female



LB-SJ-50500-2.4F Broadband  
Dual Polarization Horn Antenna  
5-50GHz 12dB Gain 2.4mm  
Female



LB-SJ-50500-1.85F Broadband  
Dual Polarization Horn Antenna  
5-50GHz 12dB Gain 1.85mm  
Female

## About this Datasheet

<ul style="list-style-type: none"> <li>● <b>Product Information</b> Product Link: <a href="https://www.ainfoinc.com/lb-180500-2-4f-broadband-horn-antenna-18-50-ghz-15db-gain-2-4mm-female">https://www.ainfoinc.com/lb-180500-2-4f-broadband-horn-antenna-18-50-ghz-15db-gain-2-4mm-female</a> Data subject to change without notice. © A-INFO INC. 2024. All Rights Reserved</li> </ul>	<ul style="list-style-type: none"> <li>● <b>Contact Us</b> Address: 60 Tesla, Irvine, CA 92618, USA  Website: <a href="http://www.ainfoinc.com">www.ainfoinc.com</a>  Email: <a href="mailto:sales@ainfoinc.com">sales@ainfoinc.com</a></li> </ul>	<ul style="list-style-type: none"> <li>● <b>Phone &amp; Fax</b> Phone: +1-949-639-9688 +1-949-639-9608  Fax: +1-949-639-9670</li> </ul>
---	--	---