



LB-SJ-60180-SF Broadband Dual Polarization Horn Antenna 6-18GHz
12dB Gain SMA Female

Broadband Dual Polarization Horn Antenna Operating From 6GHz to
18GHz With a Nominal 12dB Gain With SMA Female Connector

Product Information

SKU	LB-SJ-60180-SF
-----	----------------

Description

Broadband Dual Polarization Horn Antenna LB-SJ-60180-SF, operating from 6 to 18GHz with a nominal 12dB gain and low VSWR 2.0:1 with SMA Female output connector. The model LB-SJ-60180-SF has uniform gain through its frequency span, providing efficient performance characteristics and directionality. It can handle 25W continuously and 40W peak power. Constructed of lightweight corrosion-resistant aluminum, the antenna will provide years of trouble-free indoor and outdoor service. This horn antenna has dual linear polarization and ideally suited for EMI testing, direction finding, surveillance, antenna gain and pattern measurements and other applications.

Technical Specification

Electrical Specification		Interface	
Frequency, Min (GHz)	6	Output Type	Coaxial
Frequency, Max (GHz)	18	Connector	SMA
Gain, Typ (dBi)	12	Connector Gender	Female
Polarization	Dual Linear	Mechanical Specification	
3dB Beamwidth, E-Plane, Min (Deg.)	24	Body Material	Al
3dB Beamwidth, E-Plane, Max (Deg.)	66	Finish	Chemical Conversion Coating, Gray Paint
3dB Beamwidth, H-Plane, Min (Deg.)	28	Size, W (mm)	43.1
3dB Beamwidth, H-Plane, Max (Deg.)	77	Size, H (mm)	43.1
Cross Pol. Isolation, Min (dB)	20	Size, L (mm)	79.5
Cross Pol. Isolation, Typ (dB)	30	Weight, (kg)	0.11
Port to Port Isolation, Min (dB)	30		
Port to Port Isolation, Typ (dB)	35		
VSWR, Typ	2.0:1		
Impedance, (Ohm)	50		
Power Handling, CW, (W)	25		
Power Handling, Peak, (W)	40		

Additional Information

Application	General Purpose Indoor & Outdoor, Fixed	Solution for	Antenna Measurement Reflector Feed Far-field Measurement Planar Near-Field Measurement Cylindrical Near-Field Measurement Spherical Near-Field Measurement CATR System Intergration
-------------	---	--------------	--

Outline Drawing

SMA Female Output (P/N: LB-SJ-60180-SF)

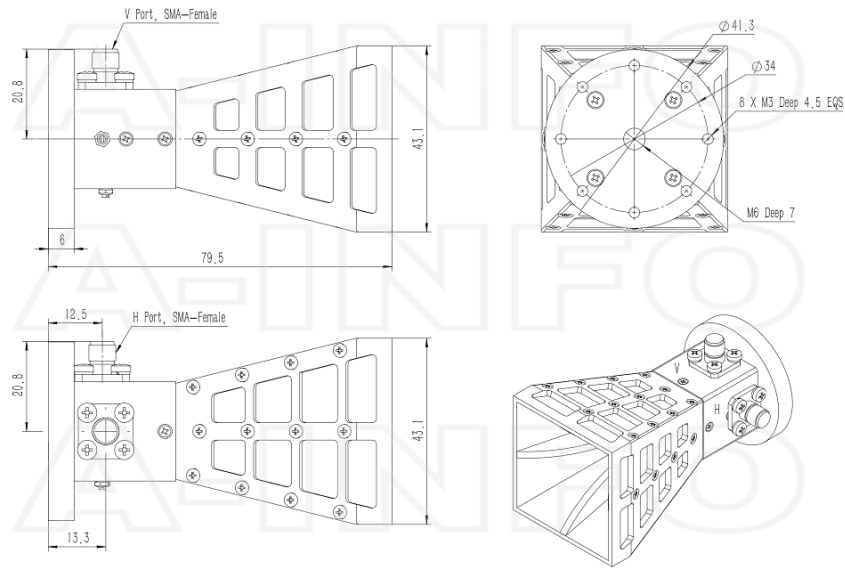

SMA Female Output with L Type Mounting Bracket (Option, P/N: LB-20180-L)

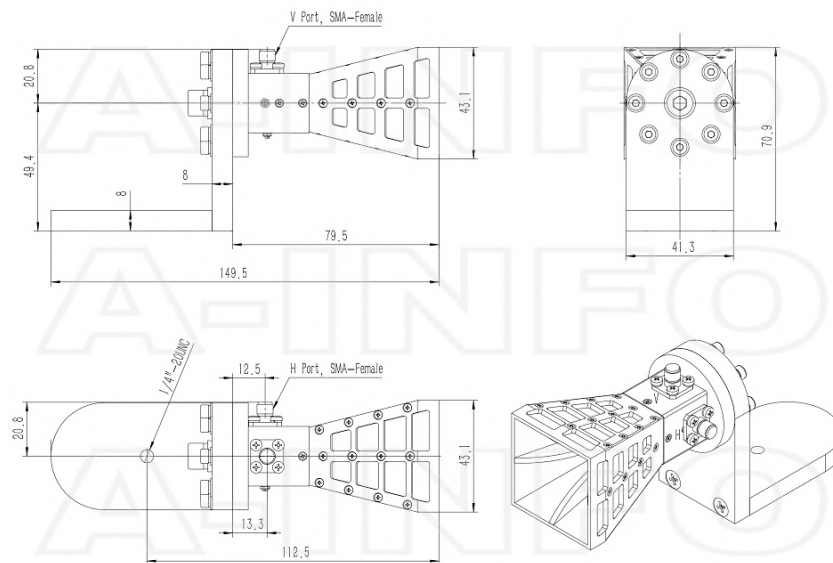

Typical Test Results

Gain

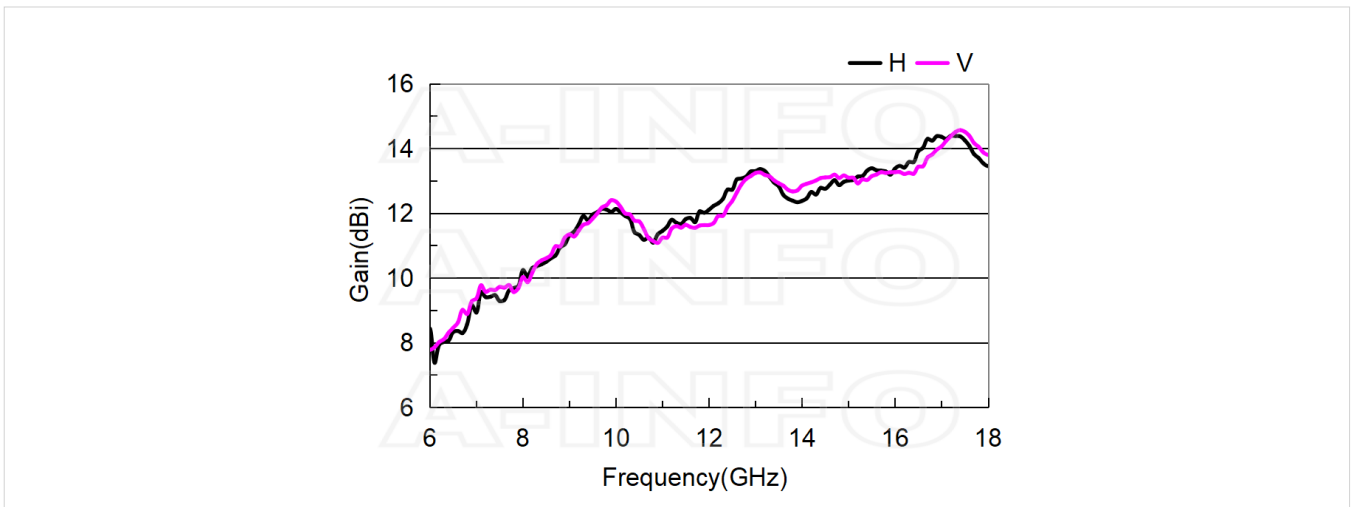

Antenna Factor

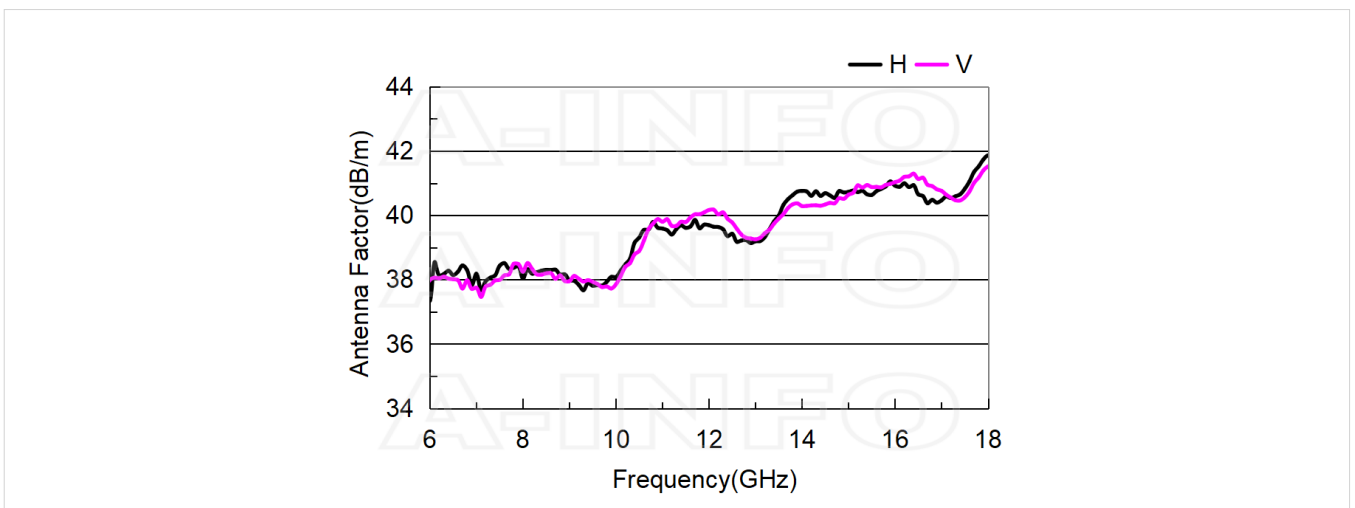

Antenna Factor (Table)

Frequency(GHz)	Vertical		Horizontal	
	Gain(dBi)	AF(dB/m)	Gain(dBi)	AF(dB/m)
6.0	7.78	37.99	8.43	37.35
7.0	9.36	37.75	8.93	38.18
8.0	10.02	38.25	10.24	38.03
9.0	11.34	37.95	11.32	37.98
10.0	12.36	37.85	12.13	38.08
11.0	11.24	39.80	11.45	39.59
12.0	11.63	40.16	12.10	39.69
13.0	13.24	39.25	13.30	39.19
14.0	12.85	40.28	12.38	40.76
15.0	13.09	40.64	13.00	40.73
16.0	13.26	41.03	13.37	40.92
17.0	14.06	40.76	14.36	40.46
18.0	13.80	41.52	13.45	41.86

Cross Polarization Isolation

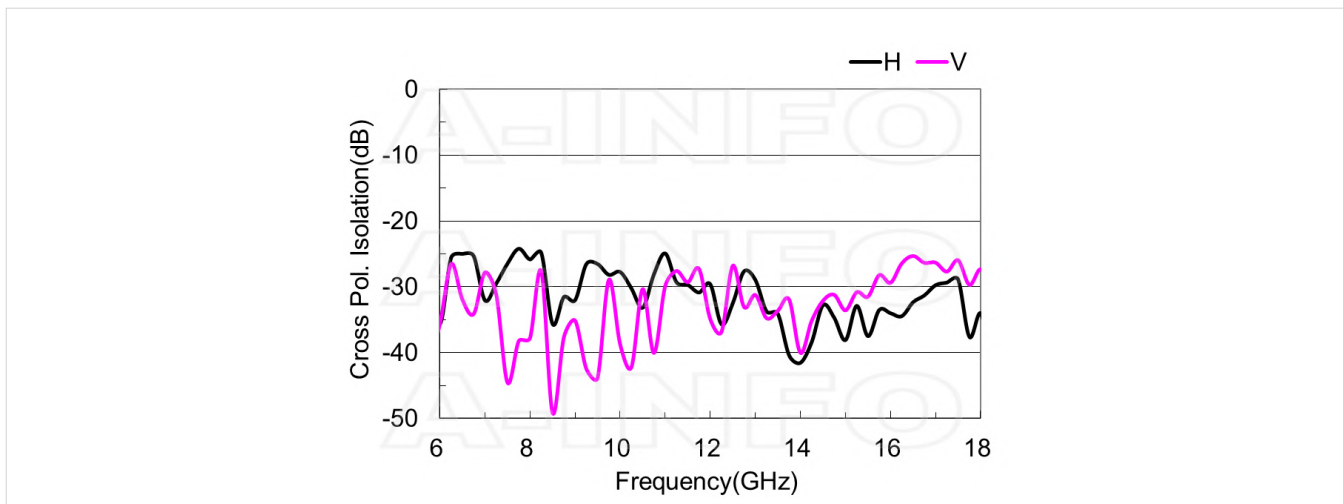

Port to Port Isolation

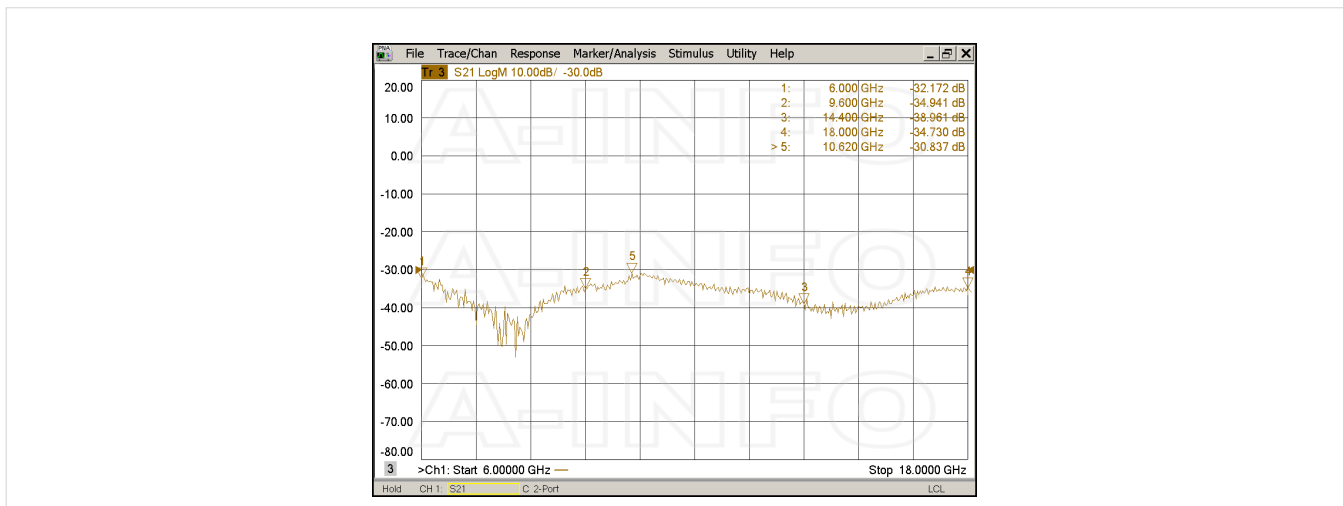

VSWR

Port-H

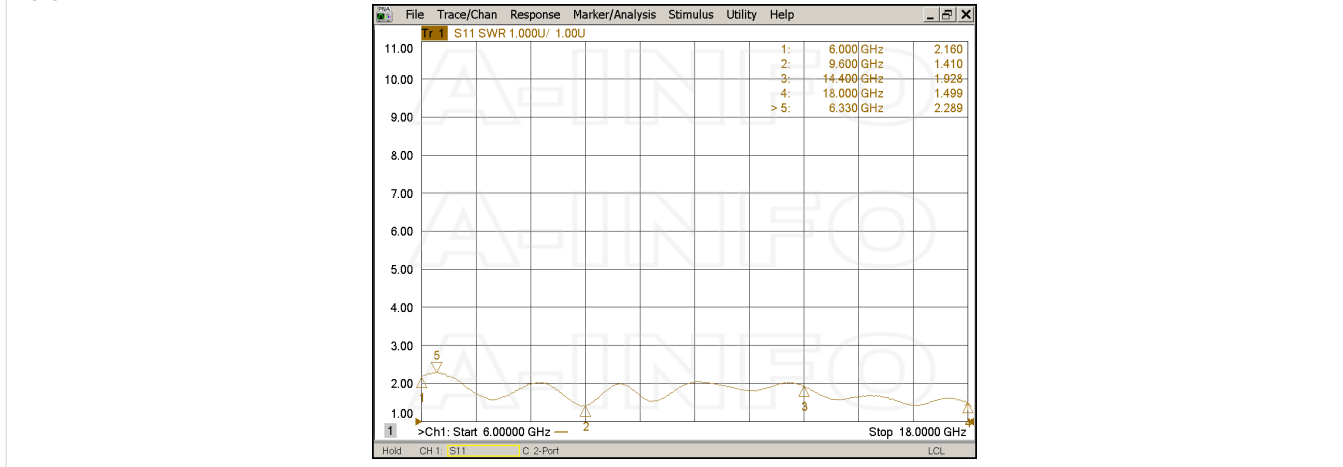

Port-V

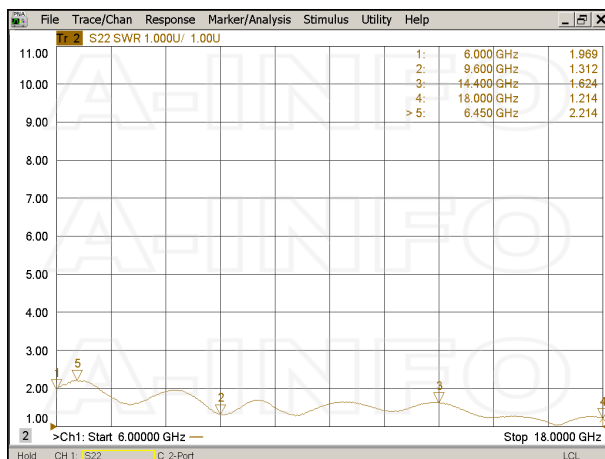

Beamwidth

3dB Beamwidth

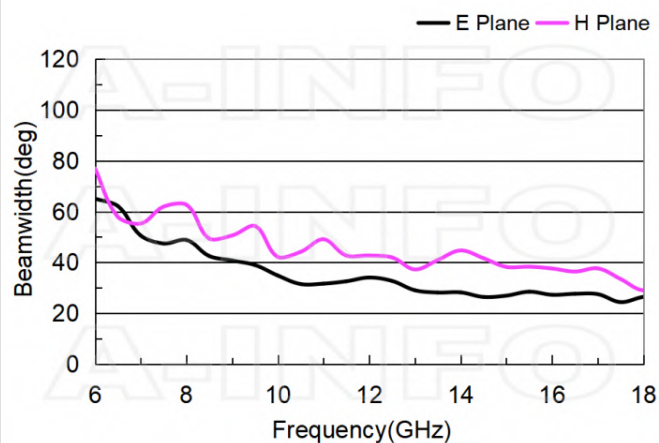

10dB Beamwidth

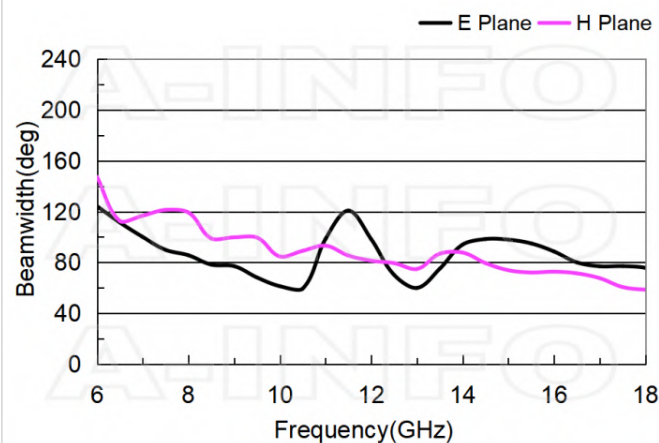

Pattern 1

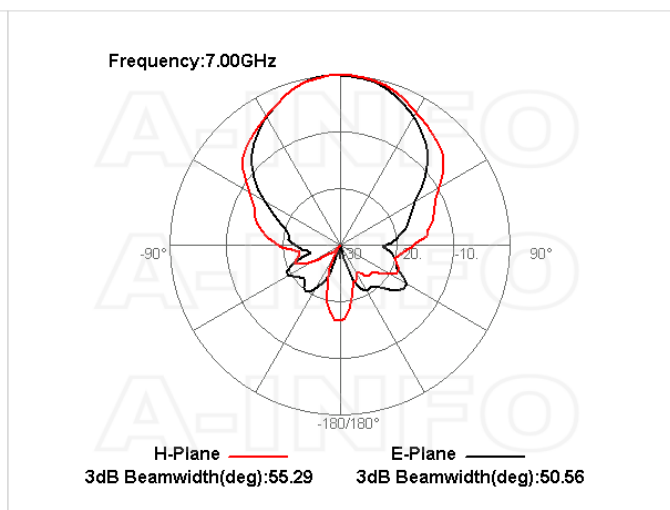
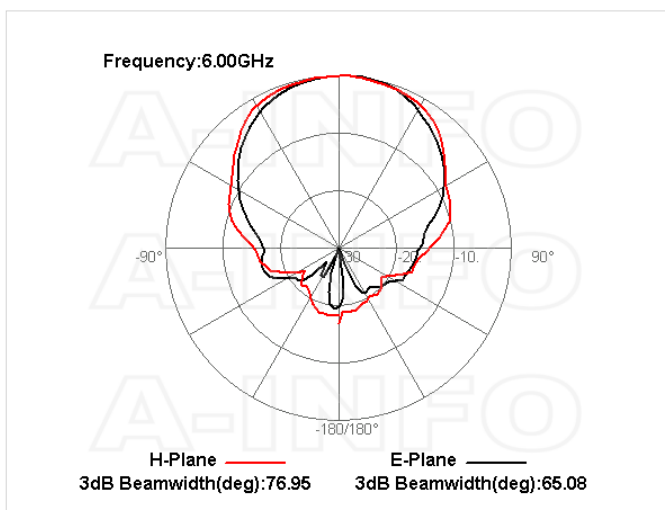

Frequency:8.00GHz

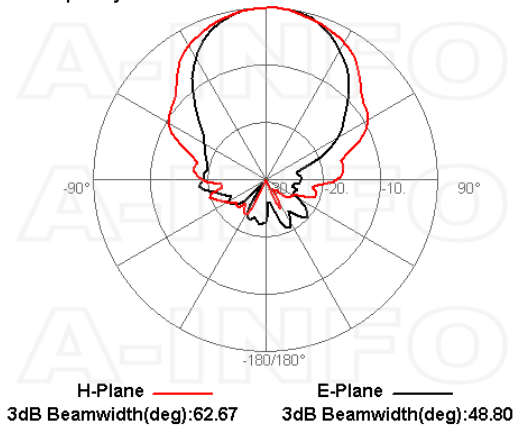

Frequency:9.00GHz

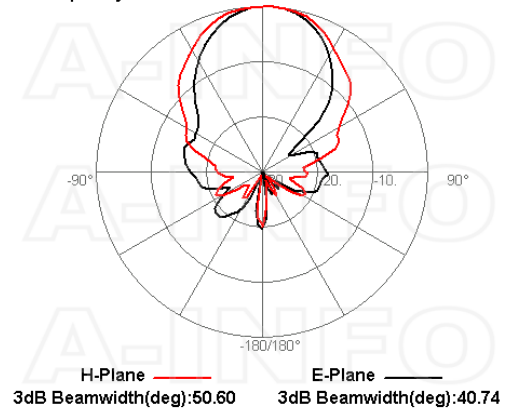

Frequency:10.00GHz

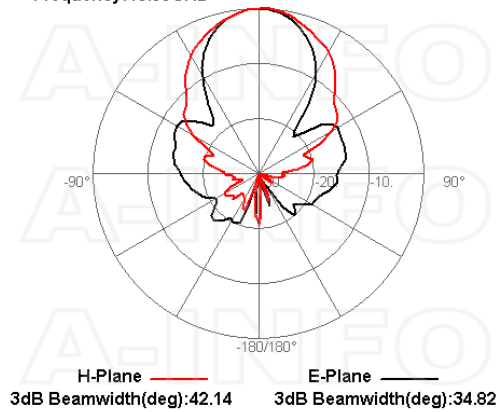

Frequency:11.00GHz

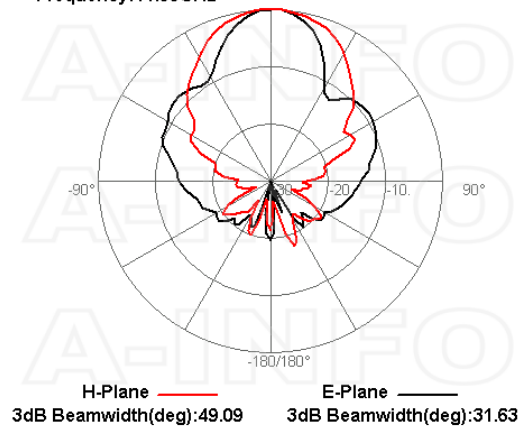

Frequency:12.00GHz

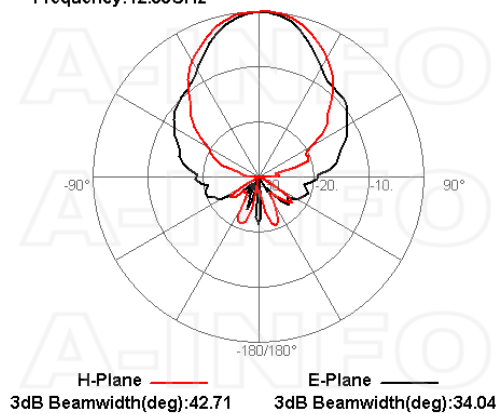

Frequency:13.00GHz

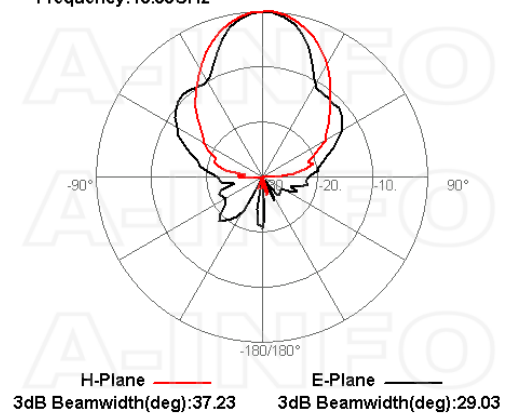

Frequency:14.00GHz

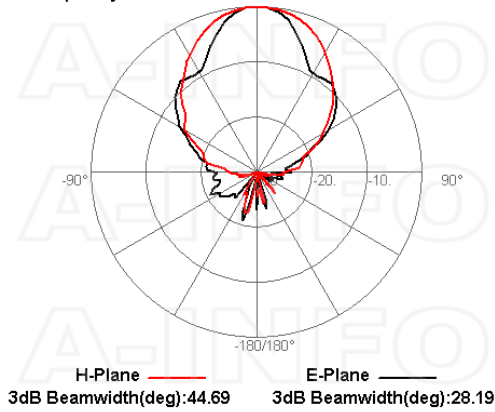

Frequency:15.00GHz

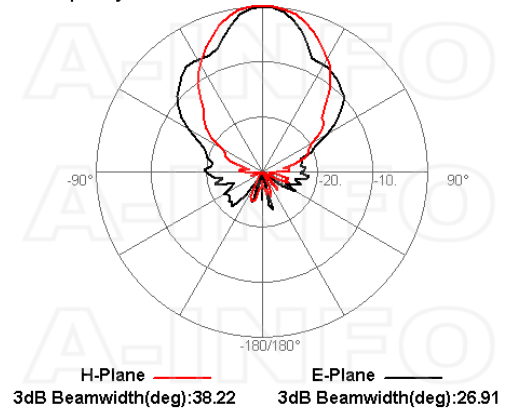

Frequency:16.00GHz

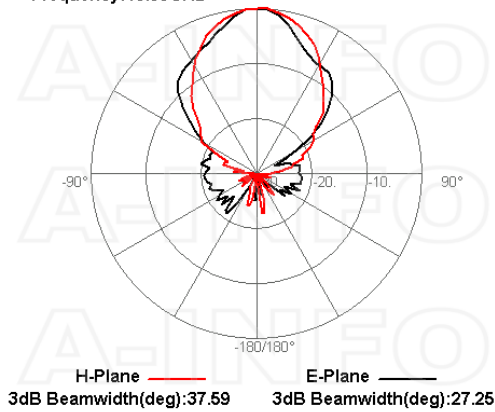

Frequency:17.00GHz

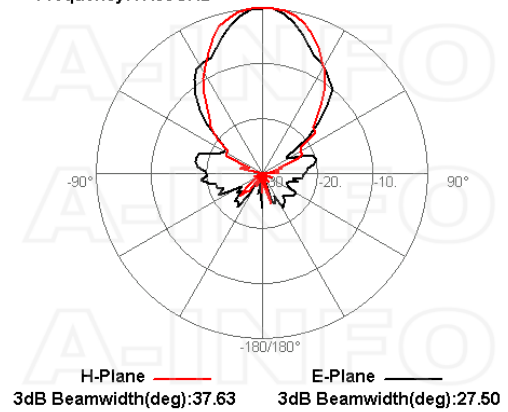

Frequency:18.00GHz

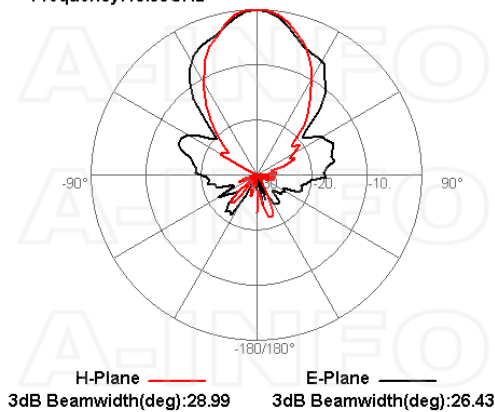

Related Products



LB-20180-L L Type Mounting Bracket



Tripod_15Kg Al Alloy Tripod



3033HL Wooden Tripod



3033QM Wooden Tripod Metalfree



Carrying Case_LB-SJ-60180 Al Alloy Carrying Case



SM-SM-A050-500 Flexible Cable Assembly 500mm DC- 26.5GHz SMA Male to SMA Male



SM-SM-A050-1000 Flexible Cable Assembly 1000mm DC- 26.5GHz SMA Male to SMA Male



SM-SM-A050-1500 Flexible Cable Assembly 1500mm DC- 26.5GHz SMA Male to SMA Male



SM-SM-A050-2000 Flexible Cable Assembly 2000mm DC- 26.5GHz SMA Male to SMA Male



SM-SM-A050-3000 Flexible Cable Assembly 3000mm DC- 26.5GHz SMA Male to SMA Male



SM-SM-A050-5000 Flexible Cable Assembly 5000mm DC- 26.5GHz SMA Male to SMA Male



SM-SM-A050-10000 Flexible Cable Assembly 10000mm DC- 26.5GHz SMA Male to SMA Male



SM-SM-A080-500 Flexible Cable Assembly 500mm DC- 26.5GHz SMA Male to SMA Male



SM-SM-A080-1000 Flexible Cable Assembly 1000mm DC- 26.5GHz SMA Male to SMA Male



SM-SM-A080-1500 Flexible Cable Assembly 1500mm DC- 26.5GHz SMA Male to SMA Male



SM-SM-A080-2000 Flexible Cable Assembly 2000mm DC- 26.5GHz SMA Male to SMA Male



SM-SM-A080-3000 Flexible Cable Assembly 3000mm DC- 26.5GHz SMA Male to SMA Male



SM-SM-A080-5000 Flexible Cable Assembly 5000mm DC- 26.5GHz SMA Male to SMA Male



SM-SM-A080-10000 Flexible Cable Assembly 10000mm DC- 26.5GHz SMA Male to SMA Male



SM-SM-A080-20000 Flexible Cable Assembly 20000mm DC- 26.5GHz SMA Male to SMA Male



SM-SM-A100-500 Flexible Cable Assembly 500mm DC- 18GHz SMA Male to SMA Male



SM-SM-A100-1000 Flexible Cable Assembly 1000mm DC- 18GHz SMA Male to SMA Male



SM-SM-A100-1500 Flexible Cable Assembly 1500mm DC- 18GHz SMA Male to SMA Male



SM-SM-A100-2000 Flexible Cable Assembly 2000mm DC- 18GHz SMA Male to SMA Male



SM-SM-A100-3000 Flexible Cable Assembly 3000mm DC- 18GHz SMA Male to SMA Male



SM-SM-A100-5000 Flexible Cable Assembly 5000mm DC- 18GHz SMA Male to SMA Male



SM-SM-A100-10000 Flexible Cable Assembly 10000mm DC- 18GHz SMA Male to SMA Male

About this Datasheet

<ul style="list-style-type: none"> ● Product Information Product Link: https://www.ainfoinc.com/lb-sj-60180-sf-broadband-dual-polarization-horn-antenna-6-18-ghz-12db-gain-sma-female Data subject to change without notice. © A-INFO INC. 2024. All Rights Reserved 	<ul style="list-style-type: none"> ● Contact Us Address: 60 Tesla, Irvine, CA 92618, USA Website: www.ainfoinc.com Email: sales@ainfoinc.com 	<ul style="list-style-type: none"> ● Phone & Fax Phone: +1-949-639-9688 +1-949-639-9608 Fax: +1-949-639-9670
---	--	--