



LB-SJ-40180-NF Broadband Dual Polarization Horn Antenna 4-18GHz
14dB Gain N Type Female

Broadband Dual Polarization Horn Antenna Operating From 4GHz to
18GHz With a Nominal 14dB Gain With N Type Female Connector

Product Information

SKU	LB-SJ-40180-NF
-----	----------------

Description

Broadband Dual Polarization Horn Antenna LB-SJ-40180-NF, operating from 4 to 18GHz with a nominal 14dB gain and low VSWR 1.50:1 with N Type Female output connector. The model LB-SJ-40180-NF has uniform gain through its frequency span, providing efficient performance characteristics and directionality. It can handle 25W continuously and 50W peak power. Constructed of lightweight corrosion-resistant aluminum, the antenna will provide years of trouble-free indoor and outdoor service. This horn antenna has dual linear polarization and ideally suited for EMI testing, direction finding, surveillance, antenna gain and pattern measurements and other applications.

Technical Specification

Electrical Specification		Interface	
Frequency, Min (GHz)	4	Output Type	Coaxial
Frequency, Max (GHz)	18	Connector	N Type
Gain, Typ (dBi)	14	Connector Gender	Female
Polarization	Dual Linear	Mechanical Specification	
3dB Beamwidth, E-Plane, Min (Deg.)	24	Body Material	Al
3dB Beamwidth, E-Plane, Max (Deg.)	75	Finish	Chemical Conversion Coating
3dB Beamwidth, H-Plane, Min (Deg.)	19	Size, W (mm)	107.7
3dB Beamwidth, H-Plane, Max (Deg.)	66	Size, H (mm)	107.7
Cross Pol. Isolation, Min (dB)	20	Size, L (mm)	132
Cross Pol. Isolation, Typ (dB)	30	Weight, (kg)	0.45
Port to Port Isolation, Min (dB)	30		
Port to Port Isolation, Typ (dB)	35		
VSWR, Typ	1.5:1		
Impedance, (Ohm)	50		
Power Handling, CW, (W)	25		
Power Handling, Peak, (W)	50		

Additional Information

Application	General Purpose Indoor & Outdoor, Fixed	Solution for	Antenna Measurement Reflector Feed Far-field Measurement Planar Near-Field Measurement Cylindrical Near-Field Measurement Spherical Near-Field Measurement CATR System Intergration
-------------	---	--------------	--

Outline Drawing

NFemale Output (P/N: LB-SJ-40180-NF)

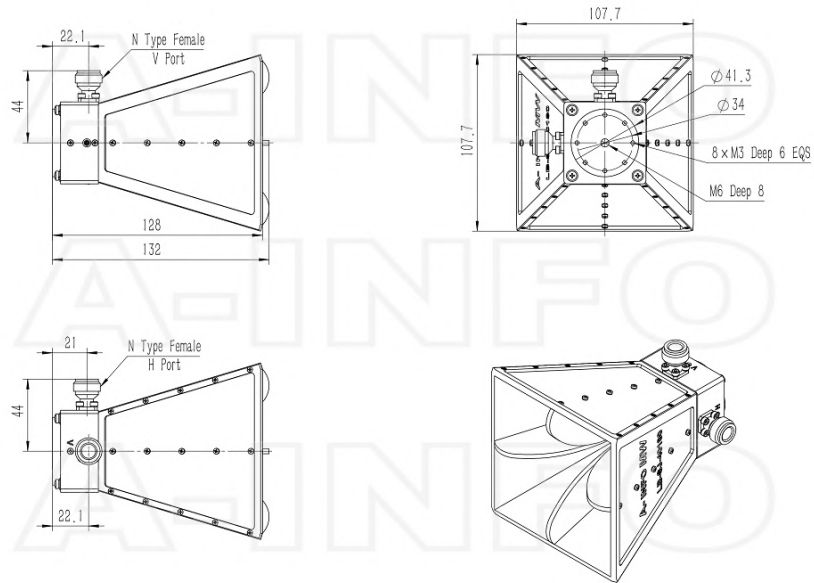

N-Female Output with L Type Mounting Bracket (Option, P/N: LB-20180-L)

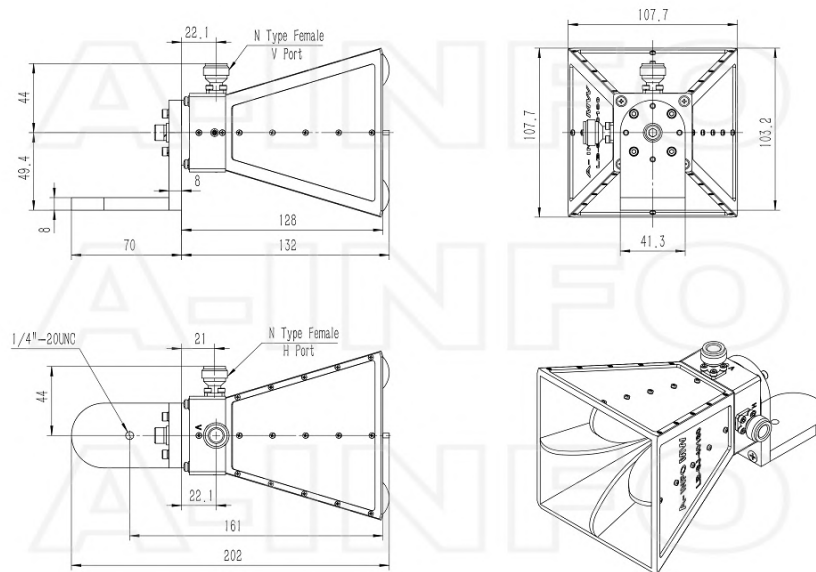

Typical Test Results

Gain

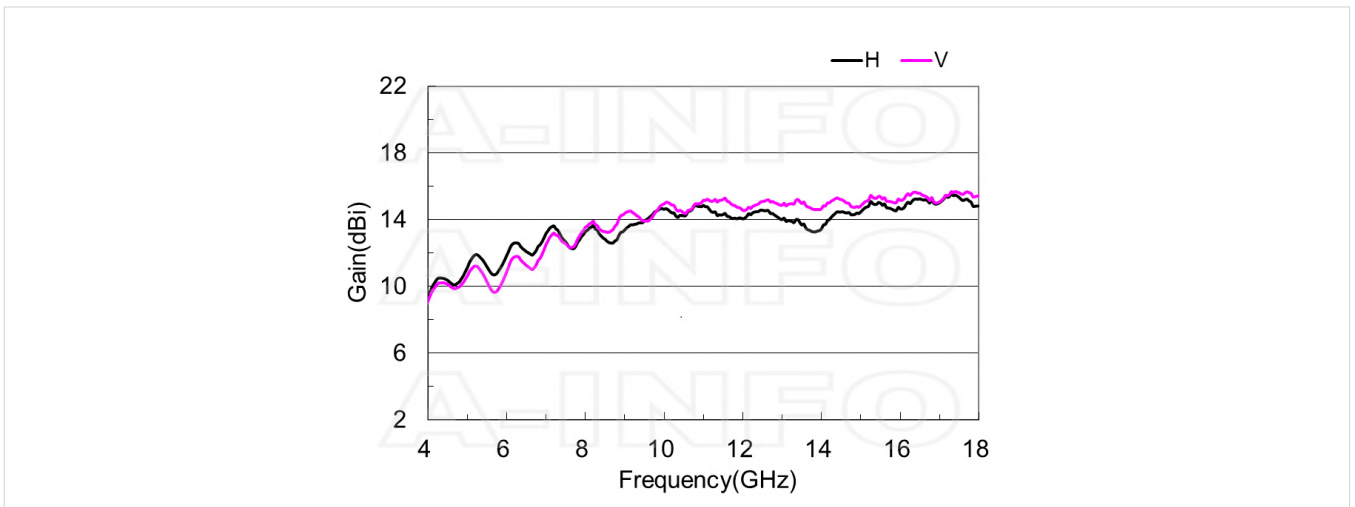

Antenna Factor

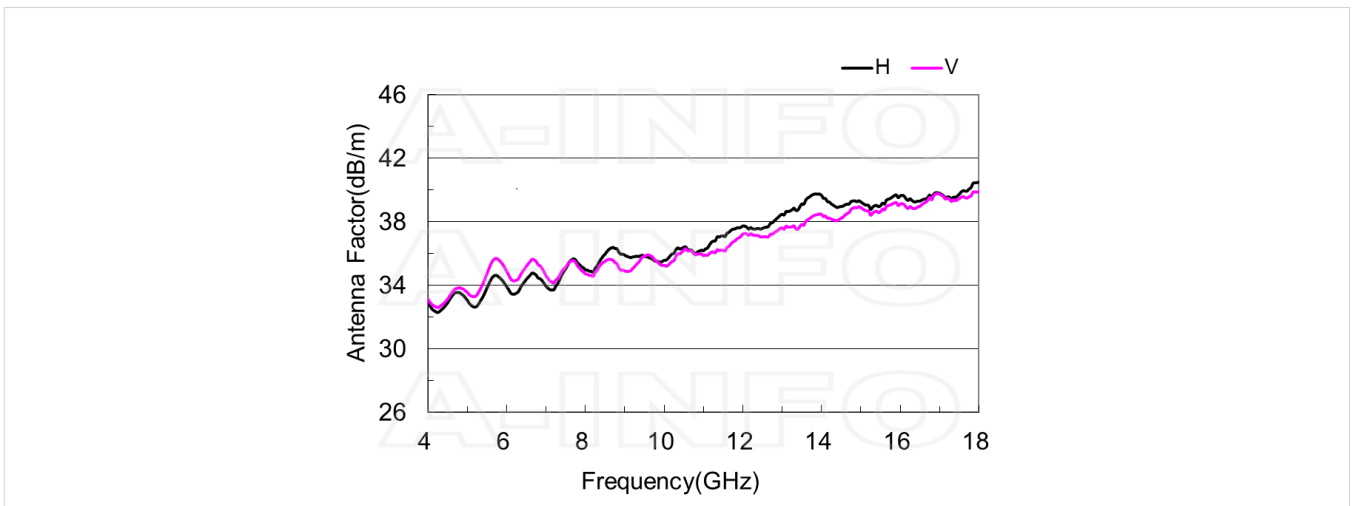

Antenna Factor (Table)

Frequency(GHz)	Horizontal		Vertical	
	Gain(dBi)	AF(dB/m)	Gain(dBi)	AF(dB/m)
4.0	9.27	32.98	9.12	33.13
5.0	11.12	33.07	10.62	33.57
6.0	11.85	33.92	10.89	34.89
7.0	13.18	33.94	12.52	34.59
8.0	13.29	34.98	13.55	34.72
9.0	13.39	35.90	14.39	34.91
10.0	14.63	35.58	14.95	35.26
12.0	14.05	37.74	14.56	37.23
14.0	13.46	39.67	14.66	38.47
16.0	14.65	39.64	15.17	39.13
18.0	14.82	40.49	15.42	39.90

Cross Polarization Isolation

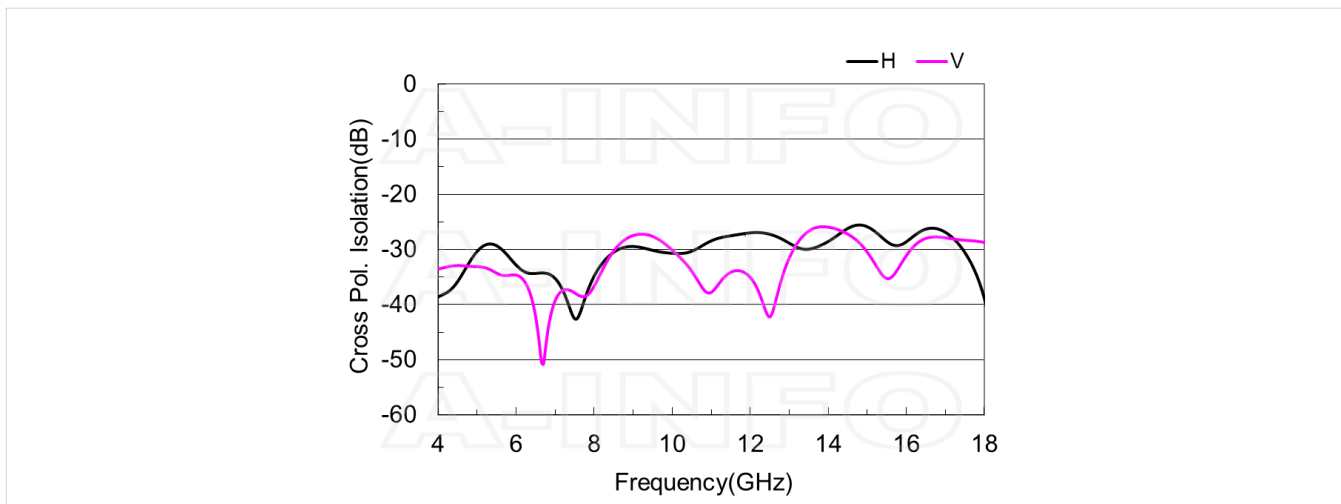

Port to Port Isolation

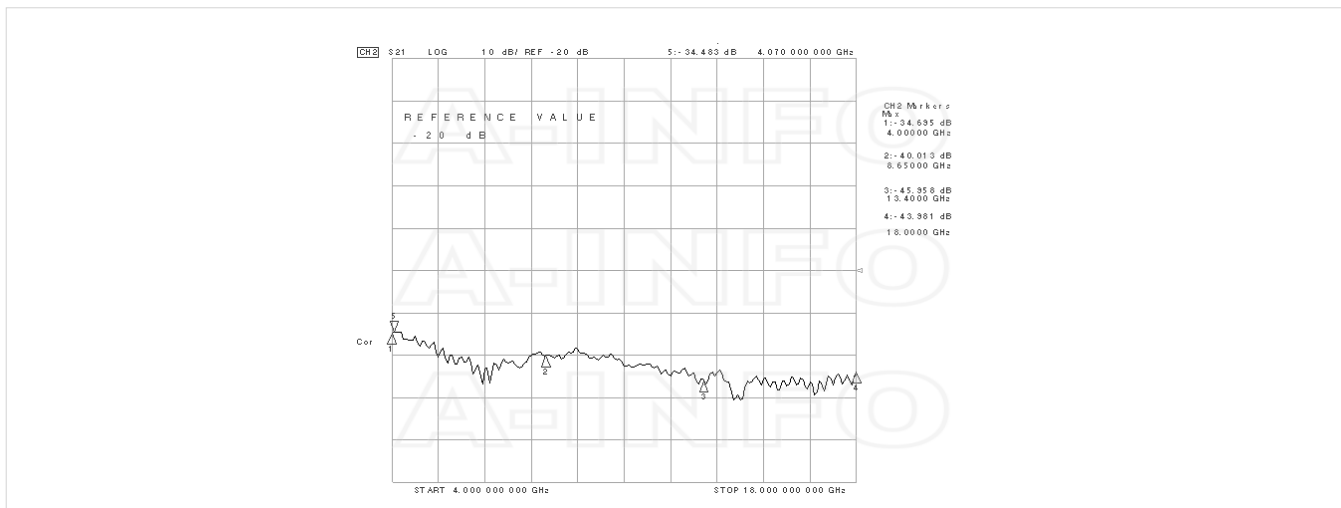

VSWR

Port-H

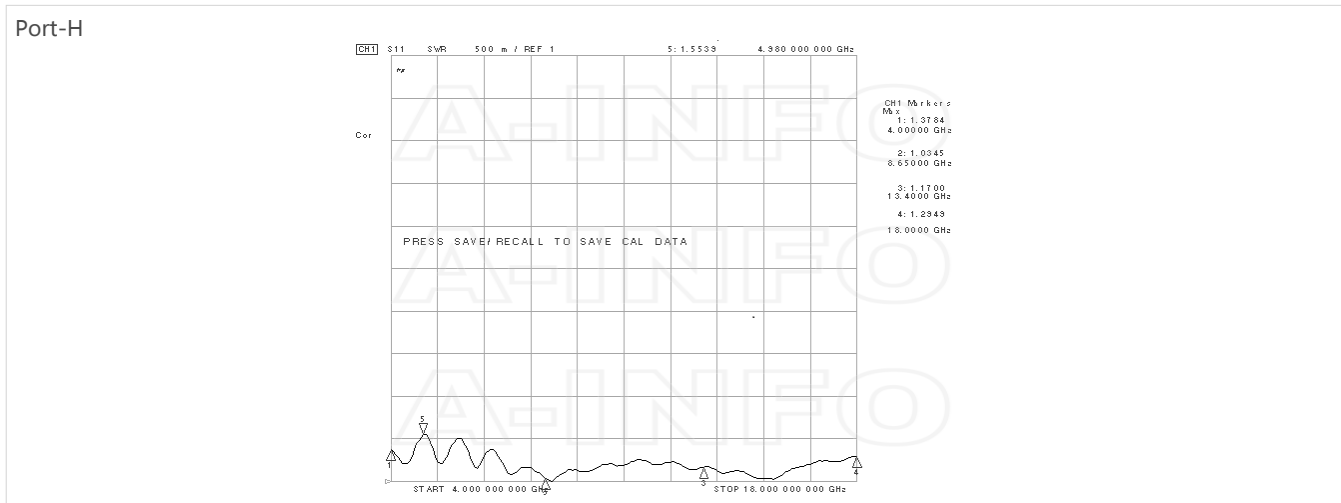

Port-V

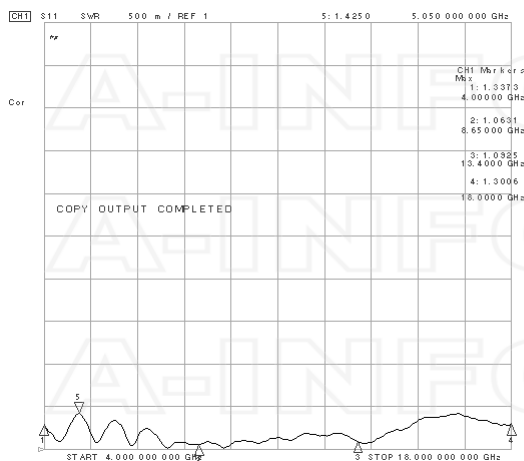

Beamwidth

3dB Beamwidth

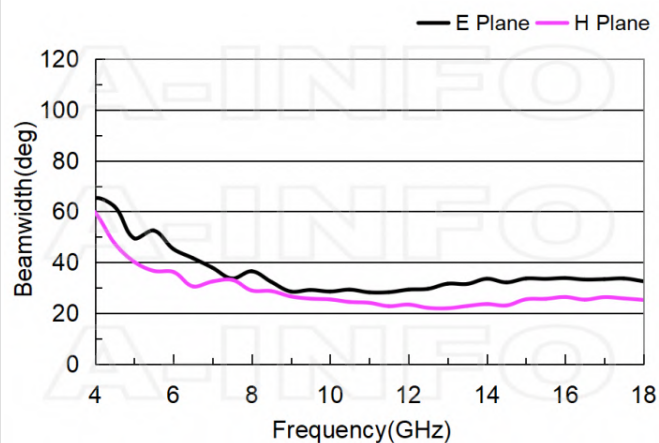

10dB Beamwidth

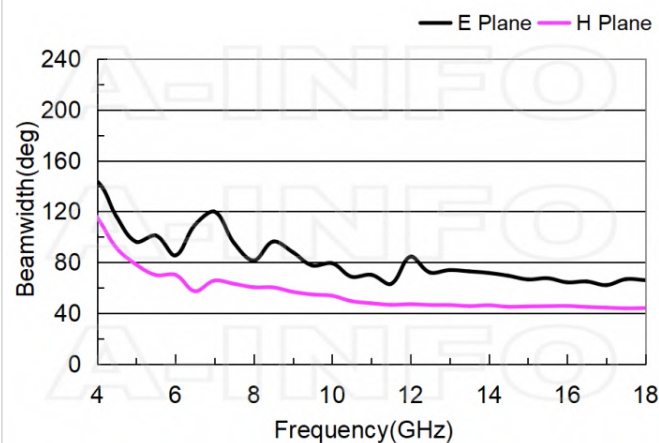

Pattern 1

Frequency:4.000GHz

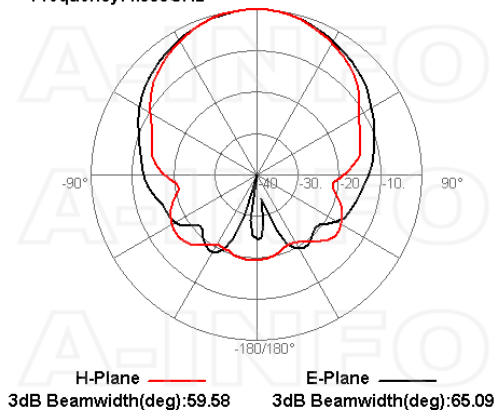

Frequency:5.000GHz

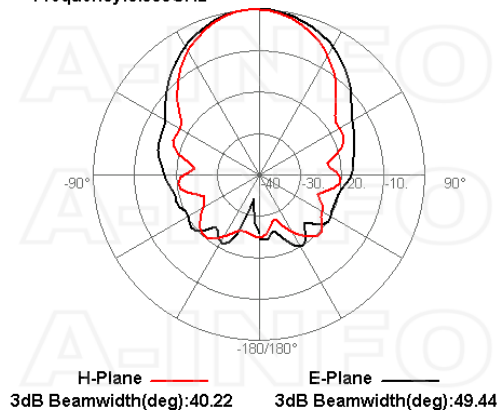

Frequency:6.000GHz

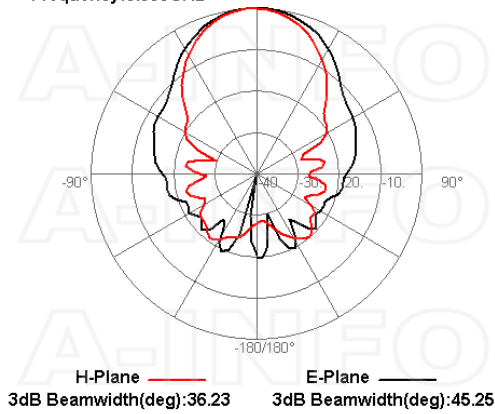

Frequency:7.000GHz

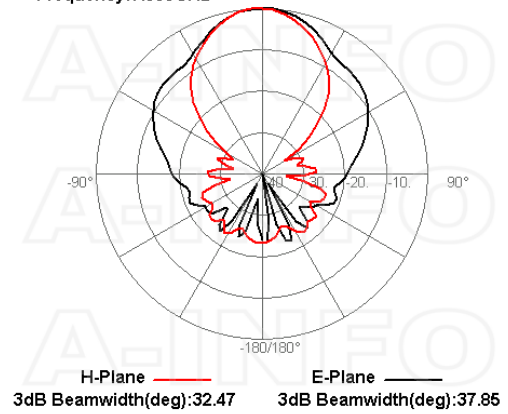

Frequency:8.000GHz

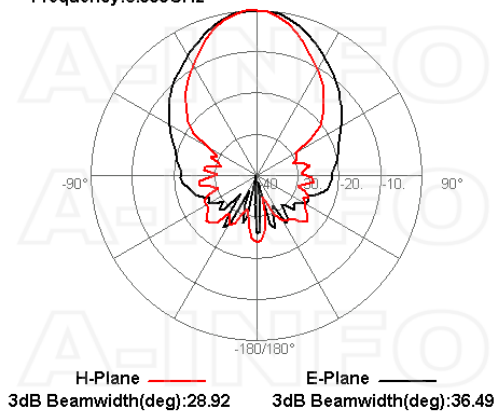

Frequency:9.000GHz

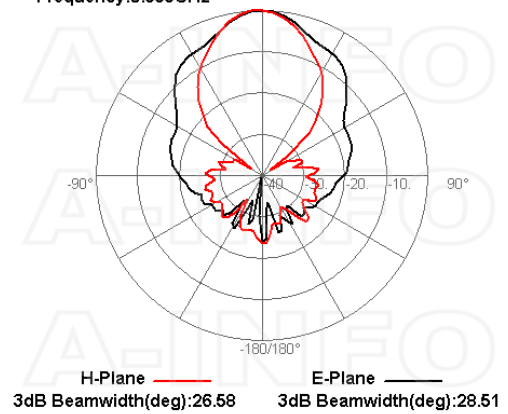

Frequency:10.000GHz

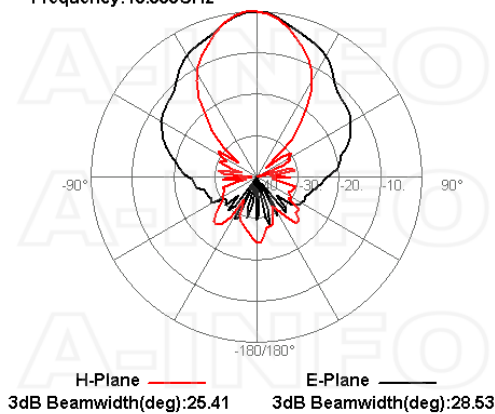

Frequency:12.000GHz

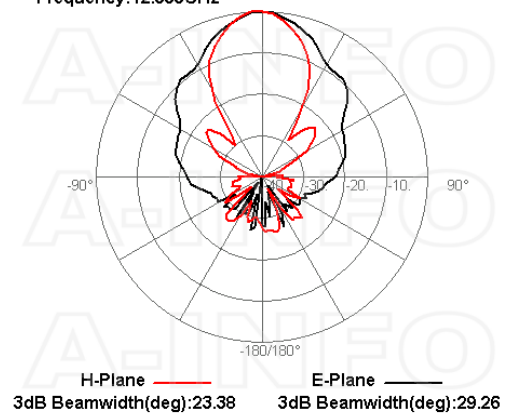

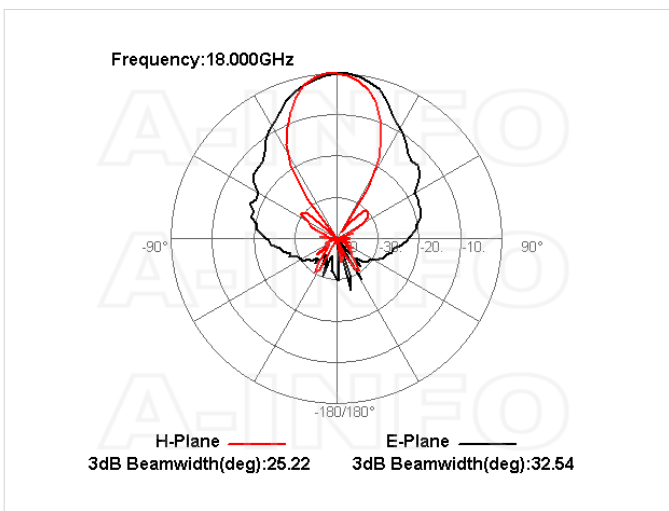
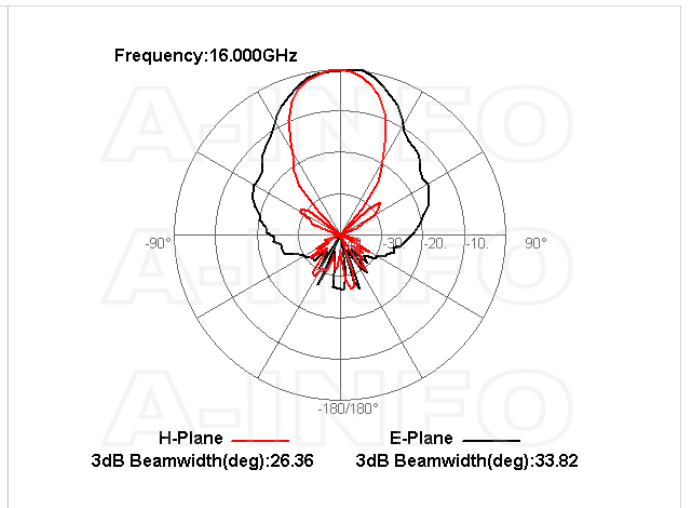
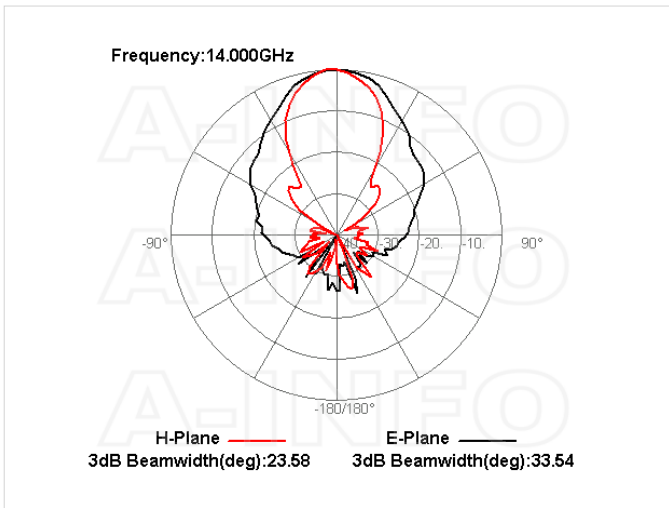

Related Products



LB-20180-L L Type Mounting Bracket



Tripod_15Kg Al Alloy Tripod



3033HL Wooden Tripod



3033QM Wooden Tripod Metalfree



Carrying Case_LB-SJ-20180 AI Alloy Carrying Case



NM-NM-A050-500 Flexible Cable Assembly 500mm DC- 18GHz N Male to N Male



NM-NM-A050-1000 Flexible Cable Assembly 1000mm DC- 18GHz N Male to N Male



NM-NM-A050-1500 Flexible Cable Assembly 1500mm DC- 18GHz N Male to N Male



NM-NM-A050-2000 Flexible Cable Assembly 2000mm DC- 18GHz N Male to N Male



NM-NM-A050-3000 Flexible Cable Assembly 3000mm DC- 18GHz N Male to N Male



NM-NM-A050-5000 Flexible Cable Assembly 5000mm DC- 18GHz N Male to N Male



NM-NM-A050-10000 Flexible Cable Assembly 10000mm DC- 18GHz N Male to N Male



NM-NM-A050-20000 Flexible Cable Assembly 20000mm DC- 18GHz N Male to N Male



NM-NM-A100-500 Flexible Cable Assembly 500mm DC- 18GHz N Male to N Male



NM-NM-A100-1000 Flexible Cable Assembly 1000mm DC- 18GHz N Male to N Male



NM-NM-A100-1500 Flexible Cable Assembly 1500mm DC- 18GHz N Male to N Male



NM-NM-A100-2000 Flexible Cable Assembly 2000mm DC- 18GHz N Male to N Male



NM-NM-A100-3000 Flexible Cable Assembly 3000mm DC- 18GHz N Male to N Male



NM-NM-A100-5000 Flexible Cable Assembly 5000mm DC- 18GHz N Male to N Male



NM-NM-A100-10000 Flexible Cable Assembly 10000mm DC- 18GHz N Male to N Male



NM-NM-A100-20000 Flexible Cable Assembly 20000mm DC-18GHz N Male to N Male

About this Datasheet

<ul style="list-style-type: none"> ● Product Information <p>Product Link: https://www.ainfoinc.com/lb-sj-40180-nf-broadband-dual-polarization-horn-antenna-4-18-ghz-14db-gain-n-type-female Data subject to change without notice. © A-INFO INC. 2024. All Rights Reserved</p>	<ul style="list-style-type: none"> ● Contact Us <p>Address: 60 Tesla, Irvine, CA 92618, USA</p> <p>Website: www.ainfoinc.com</p> <p>Email: sales@ainfoinc.com</p>	<ul style="list-style-type: none"> ● Phone & Fax <p>Phone: +1-949-639-9688 +1-949-639-9608</p> <p>Fax: +1-949-639-9670</p>
---	--	---