



LB-SJ-180400-KF Broadband Dual Polarization Horn Antenna 18-40GHz
15dB Gain 2.92mm Female

Broadband Dual Polarization Horn Antenna Operating From 18GHz to 40GHz With a Nominal 15dB Gain With 2.92mm Female Connector

Product Information

SKU	LB-SJ-180400-KF	Patents	US D869447S (USA)
-----	-----------------	---------	-------------------

Description

Broadband Dual Polarization Horn Antenna LB-SJ-180400-KF, operating from 18 to 40GHz with a nominal 15dB gain and low VSWR 2.0:1 with 2.92mm Female output connector. The model LB-SJ-180400-KF has uniform gain through its frequency span, providing efficient performance characteristics and directionality. It can handle 10W continuously and 20W peak power. Constructed of high thermal and electrical conductivity durable copper, the antenna will provide years of trouble-free indoor and outdoor service. This horn antenna has dual linear polarization and ideally suited for EMI testing, direction finding, surveillance, antenna gain and pattern measurements and other applications.

Technical Specification

Electrical Specification		Interface	
Frequency, Min (GHz)	18	Output Type	Coaxial
Frequency, Max (GHz)	40	Connector	2.92mm(K)
Gain, Typ (dBi)	15	Connector Gender	Female
Polarization	Dual Linear	Mechanical Specification	
3dB Beamwidth, E-Plane, Min (Deg.)	26	Body Material	Cu
3dB Beamwidth, E-Plane, Max (Deg.)	44	Finish	Gold Plated, Gray Paint
3dB Beamwidth, H-Plane, Min (Deg.)	20	Size, W (mm)	34.9
3dB Beamwidth, H-Plane, Max (Deg.)	53	Size, H (mm)	34.9
Cross Pol. Isolation, Min (dB)	20	Size, L (mm)	61.5
Cross Pol. Isolation, Typ (dB)	30	Weight, (kg)	0.25
Port to Port Isolation, Min (dB)	20		
Port to Port Isolation, Typ (dB)	30		
VSWR, Typ	2.0:1		
Impedance, (Ohm)	50		
Power Handling, CW, (W)	10		
Power Handling, Peak, (W)	20		

Additional Information

Application	General Purpose Indoor & Outdoor, Fixed	Solution for	Antenna Measurement Reflector Feed Far-field Measurement Planar Near-Field Measurement Cylindrical Near-Field Measurement Spherical Near-Field Measurement CATR System Intergration
-------------	-----------------------------------------	--------------	----------------------------------------------------------------------------------------------------------------------------------------------------------------------------------------------------------

Outline Drawing

2.92mm-Female Output (P/N: LB-SJ-180400-KF)

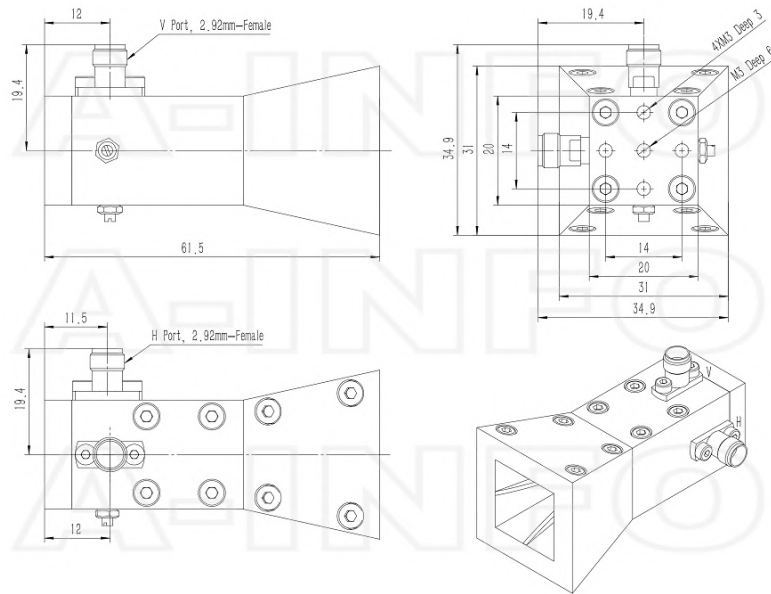

2.92mm-Female Output with L Type Mounting Bracket (Option, P/N: LB-SJ-180400-L)

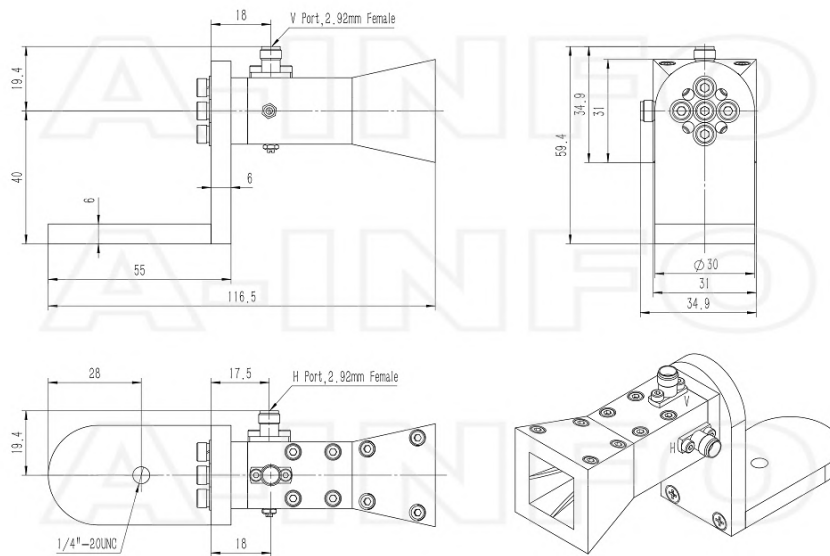

Typical Test Results

Gain

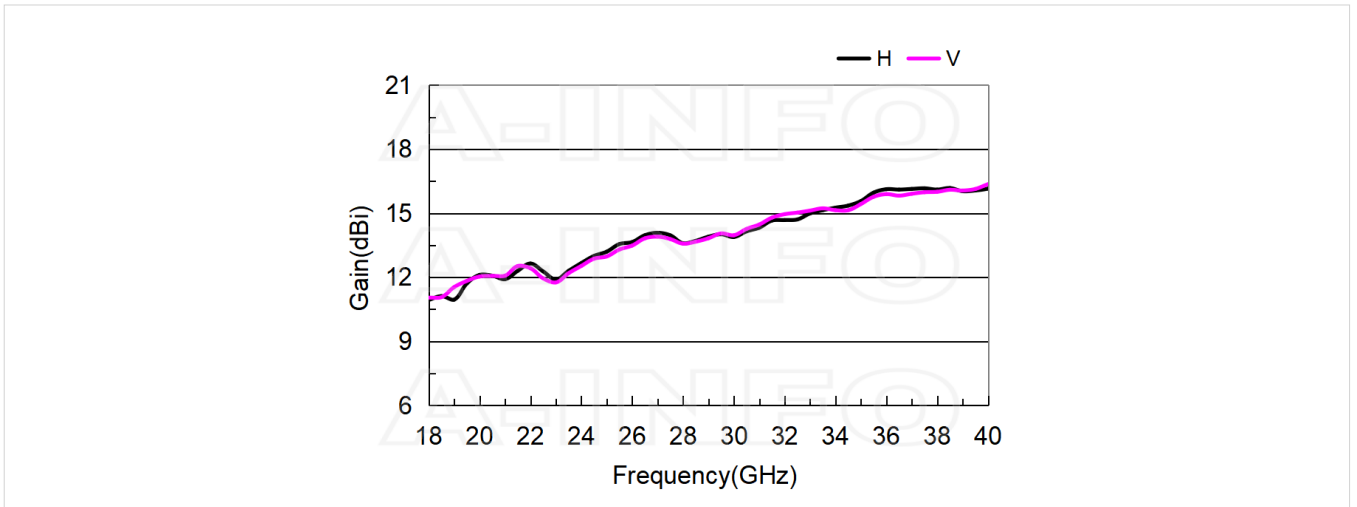

Antenna Factor

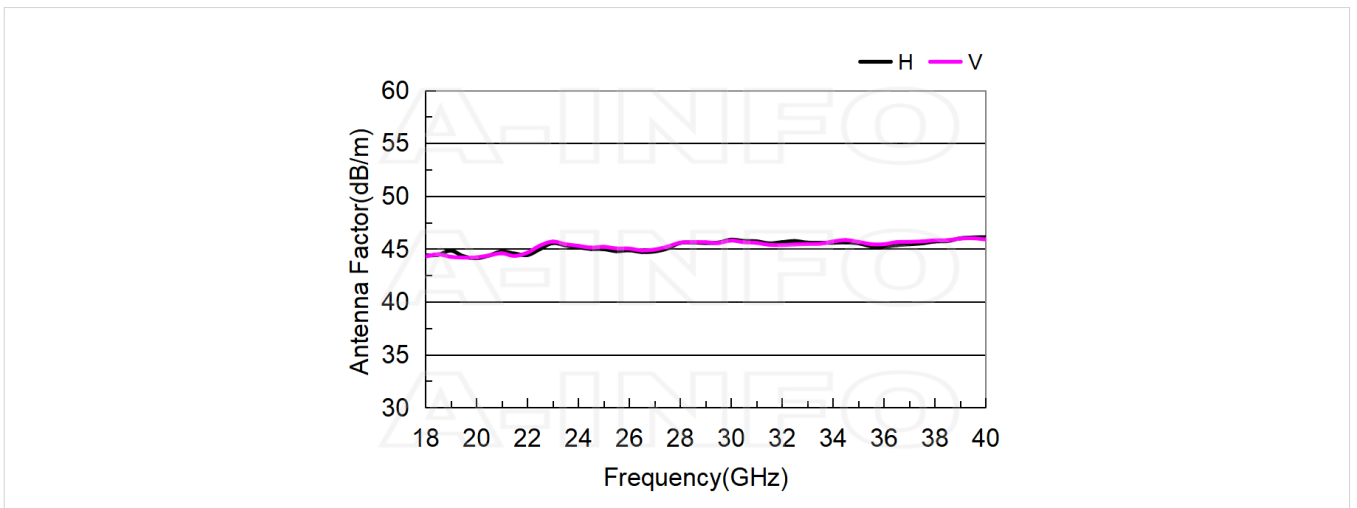

Antenna Factor (Table)

Frequency(GHz)	Horizontal		Vertical	
	Gain(dBi)	AF(dB/m)	Gain(dBi)	AF(dB/m)
18.0	10.94	44.38	11.04	44.27
20.0	12.11	44.12	12.03	44.20
22.0	12.64	44.42	12.42	44.64
24.0	12.66	45.15	12.53	45.29
26.0	13.65	44.86	13.48	45.03
28.0	13.59	45.56	13.57	45.58
30.0	13.88	45.87	13.97	45.79
32.0	14.68	45.64	14.95	45.36
34.0	15.26	45.58	15.14	45.70
36.0	16.12	45.21	15.89	45.44
38.0	16.11	45.70	16.00	45.80
40.0	16.15	46.10	16.35	45.90

Cross Polarization Isolation

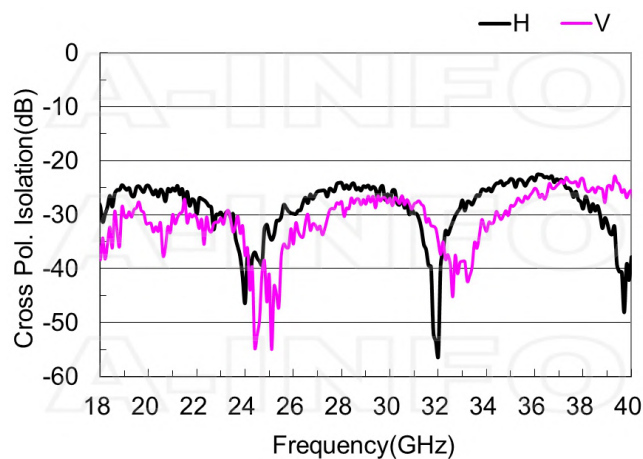

Port to Port Isolation

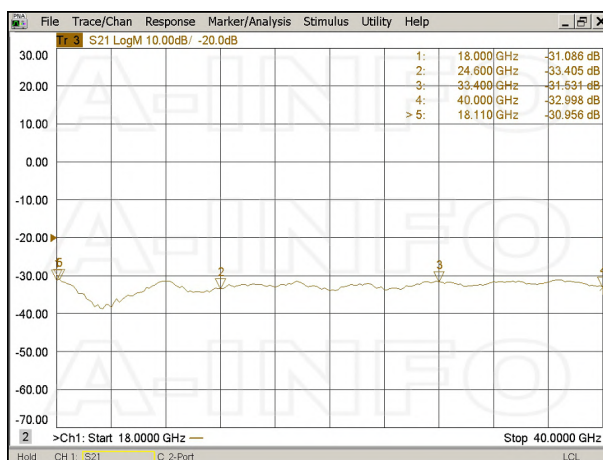

VSWR

Port-H

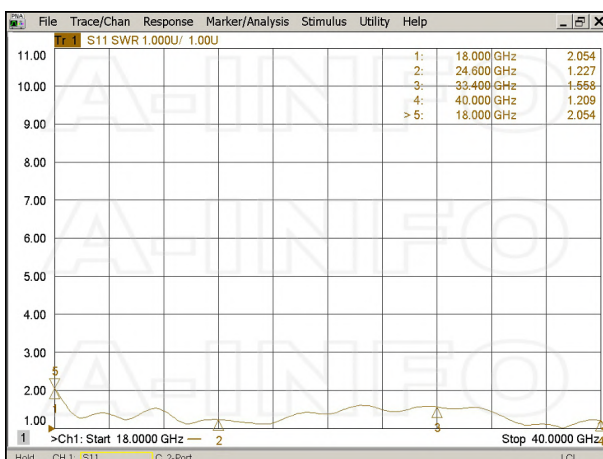

Port-V

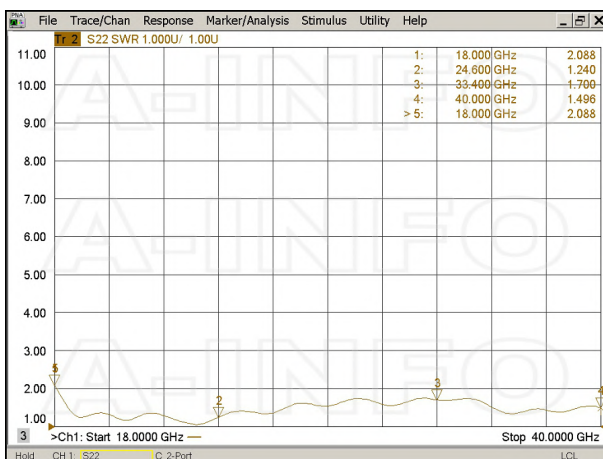

Beamwidth

3dB Beamwidth

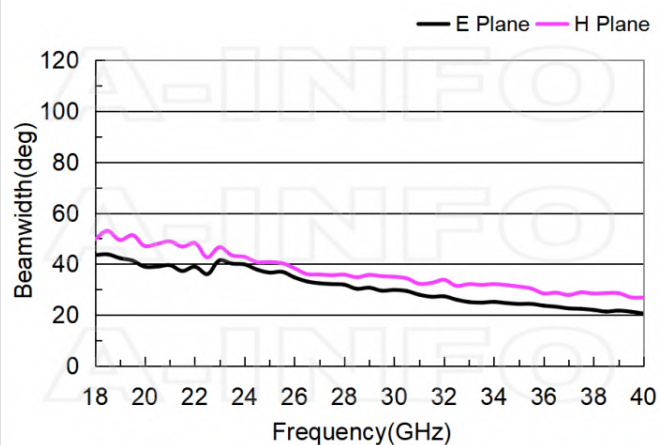

10dB Beamwidth

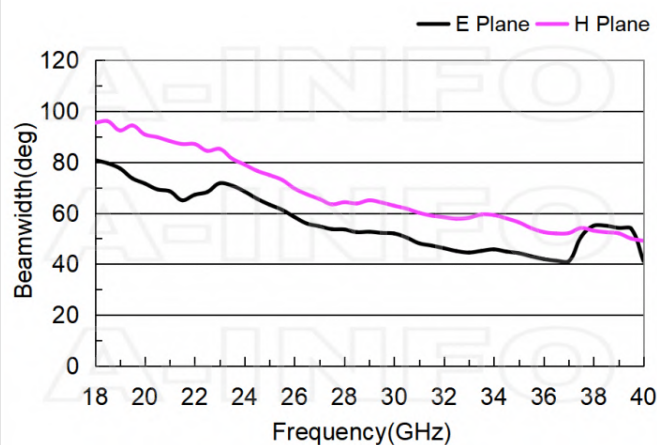

Pattern 1

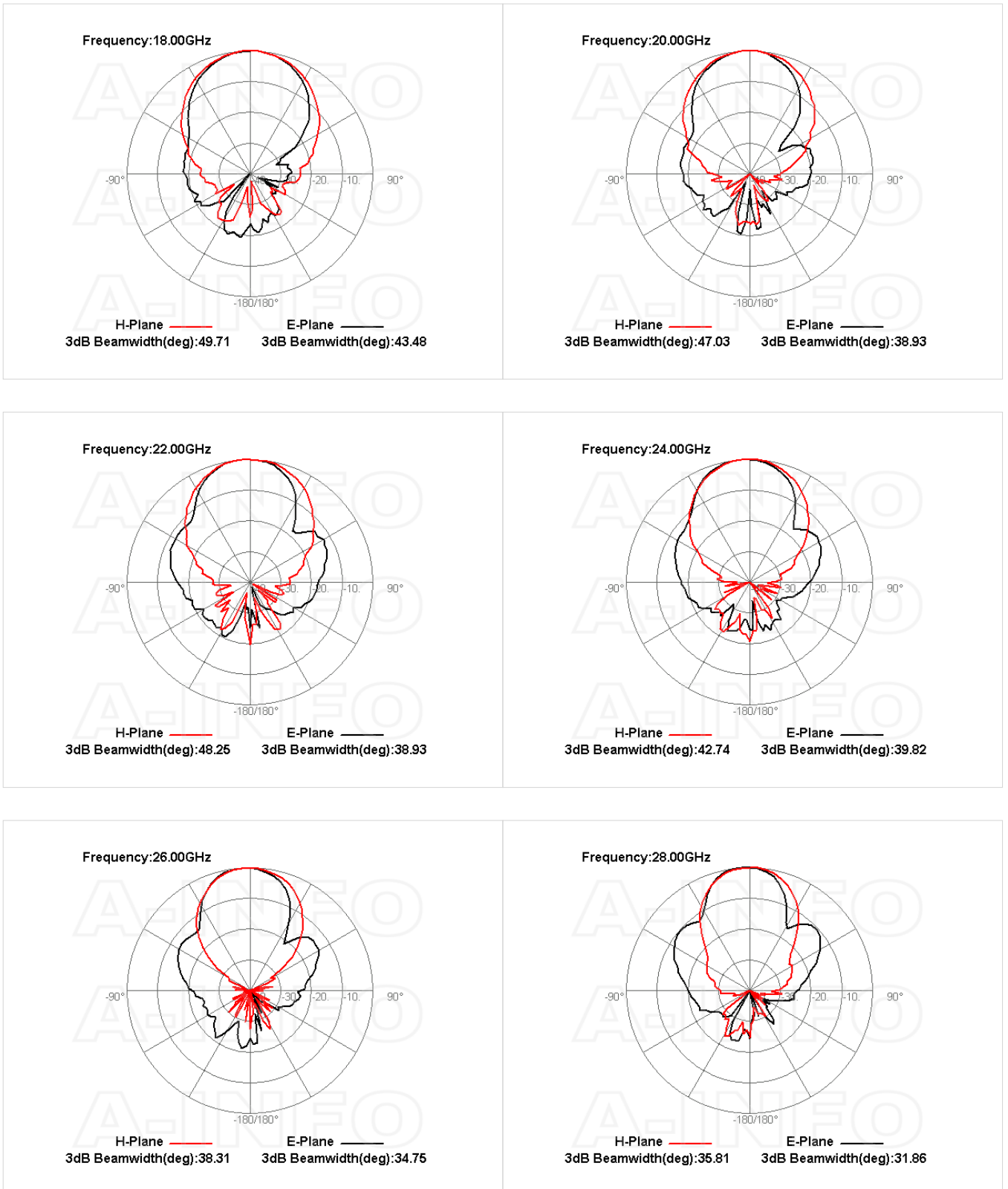

Frequency:30.00GHz

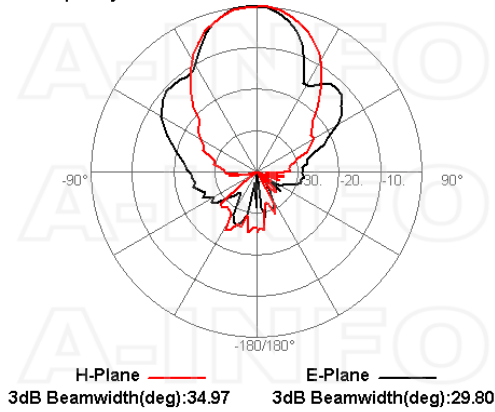

Frequency:32.00GHz

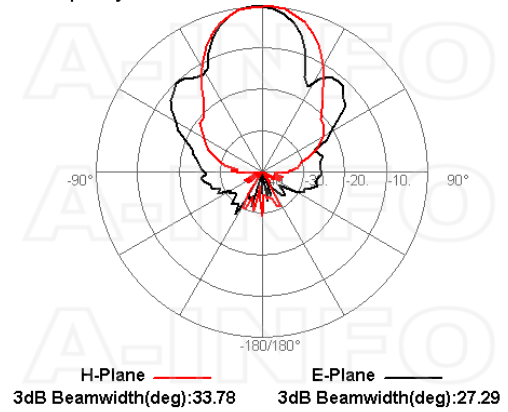

Frequency:34.00GHz

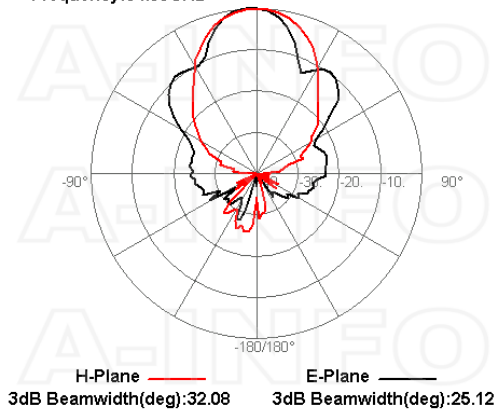

Frequency:36.00GHz

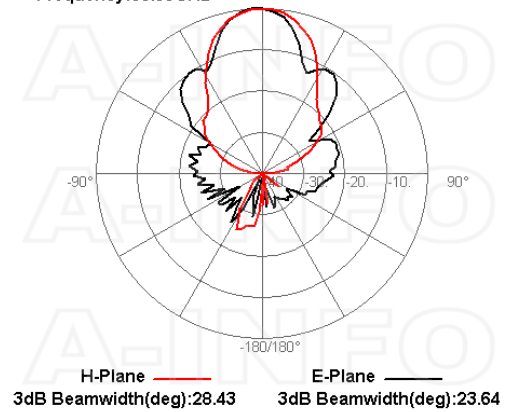

Frequency:38.00GHz

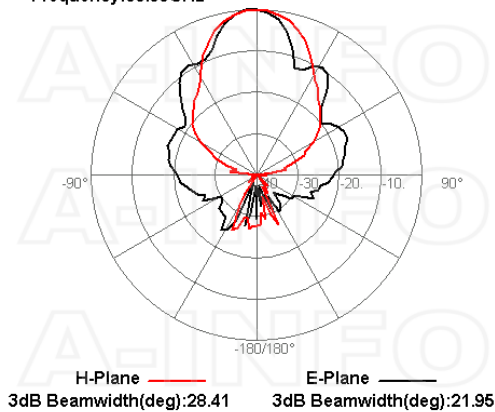

Frequency:40.00GHz

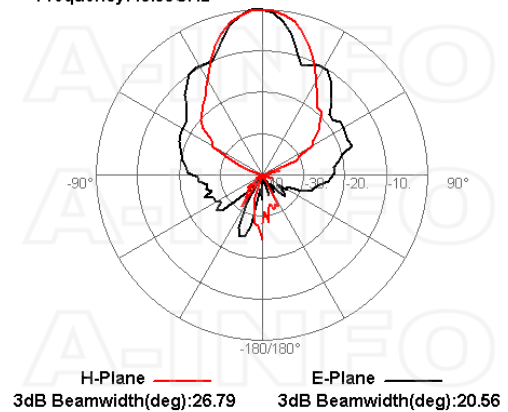

Related Products



LB-SJ-180400-L L Type Mounting Bracket



Tripod_15Kg Al Alloy Tripod



3033HL Wooden Tripod



3033QM Wooden Tripod Metalfree



Carrying Case_LB-SJ-180400 Al Alloy Carrying Case



2.92M-2.92M-A050-500 Flexible Cable Assembly 500mm DC-40GHz 2.92mm Male to 2.92mm Male



2.92M-2.92M-A050-1000 Flexible Cable Assembly 1000mm DC-40GHz 2.92mm Male to 2.92mm Male



2.92M-2.92M-A050-1500 Flexible Cable Assembly 1500mm DC-40GHz 2.92mm Male to 2.92mm Male



2.92M-2.92M-A050-2000 Flexible Cable Assembly 2000mm DC-40GHz 2.92mm Male to 2.92mm Male



2.92M-2.92M-A050-3000 Flexible Cable Assembly 3000mm DC-40GHz 2.92mm Male to 2.92mm Male



2.92M-2.92M-A050-5000 Flexible Cable Assembly 5000mm DC-40GHz 2.92mm Male to 2.92mm Male



2.92M-2.92M-A050-10000 Flexible Cable Assembly 10000mm DC-40GHz 2.92mm Male to 2.92mm Male

About this Datasheet

<ul style="list-style-type: none"> ● Product Information Product Link: https://www.ainfoinc.com/lb-sj-180400-kf-broadband-dual-polarization-horn-antenna-18-40-ghz-15db-gain-2-92mm-female Data subject to change without notice. © A-INFO INC. 2024. All Rights Reserved 	<ul style="list-style-type: none"> ● Contact Us Address: 60 Tesla, Irvine, CA 92618, USA Website: www.ainfoinc.com Email: sales@ainfoinc.com 	<ul style="list-style-type: none"> ● Phone & Fax Phone: +1-949-639-9688 +1-949-639-9608 Fax: +1-949-639-9670
---------------------------------------------------------------------------------------------------------------------------------------------------------------------------------------------------------------------------------------------------------------------------------------------------------------------------------------------------------------------------------------------------------------------------------------------------	--------------------------------------------------------------------------------------------------------------------------------------------------------------------------------------------------------------------------------------------------------------------------	------------------------------------------------------------------------------------------------------------------------------------------------------------