

LB-8400-KF Broadband Horn Antenna 0.8-40GHz 12dB Gain 2.92mm Female

Broadband Horn Antenna Operating From 0.8GHz to 40GHz With a Nominal 12dB Gain With 2.92mm Female Connector

Product Information

SKU	LB-8400-KF
-----	------------

Description

Broadband horn antenna LB-8400-KF, operating from 0.8 to 40GHz with a nominal 12dB gain and low VSWR 1.5:1 with 2.92mm Female output connector. The model LB-8400-KF has uniform gain through its frequency span, providing efficient performance characteristics and directionality. It can handle 20W continuously and 40W peak power. Constructed of lightweight corrosion-resistant aluminum, the antenna will provide years of trouble-free indoor and outdoor service. This broadband horn antenna is linearly polarized and ideally suited for EMI testing, direction finding, surveillance, antenna gain and pattern measurements and other applications..

Technical Specification

Electrical Specification		Interface	
Frequency, Min (GHz)	0.8	Output Type	Coaxial
Frequency, Max (GHz)	40	Connector	2.92mm(K)
Gain, Typ (dBi)	12	Connector Gender	Female
Polarization	Linear	Mechanical Specification	
3dB Beamwidth, E-Plane, Min (Deg.)	23	Body Material	Al
3dB Beamwidth, E-Plane, Max (Deg.)	102	Finish	Chemical Conversion Coating
3dB Beamwidth, H-Plane, Min (Deg.)	18	Size, W (mm)	244.5
3dB Beamwidth, H-Plane, Max (Deg.)	90	Size, H (mm)	144.3
Cross Pol. Isolation, Typ (dB)	25	Size, L (mm)	201
VSWR, Typ	1.5:1	Weight, (kg)	0.61
Impedance, (Ohm)	50		
Power Handling, CW, (W)	20		
Power Handling, Peak, (W)	40		

Additional Information

Application	General Purpose Indoor & Outdoor, Fixed	Solution for	Gain Reference Antenna Measurement Reflector Feed Far-field Measurement System Intergration
-------------	---	--------------	---

Outline Drawing

2.92mm-Female Output (P/N: LB-8400-KF)

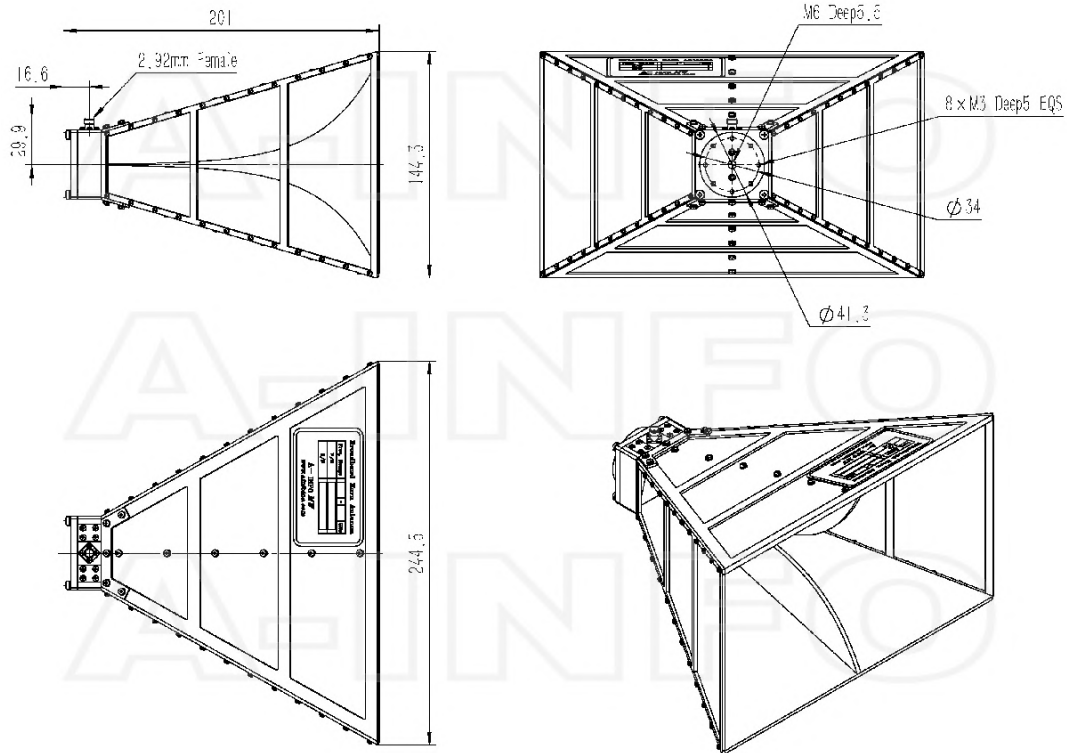

2.92mm-Female Output with L Type Mounting Bracket (Option, P/N: LB-20180-L)

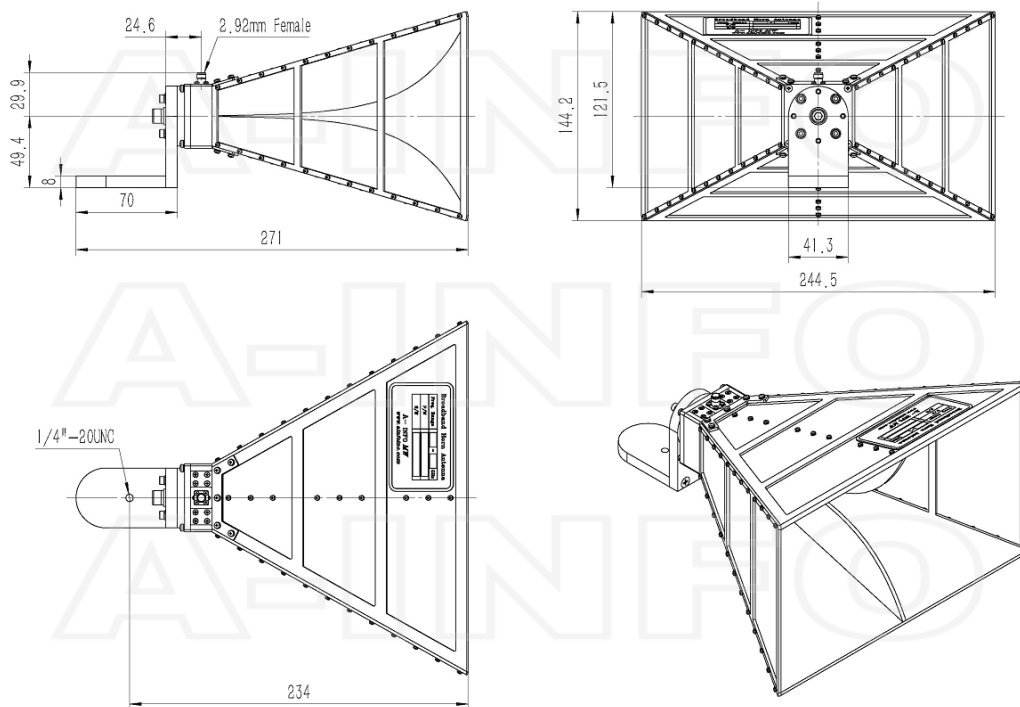

Typical Test Results

Gain

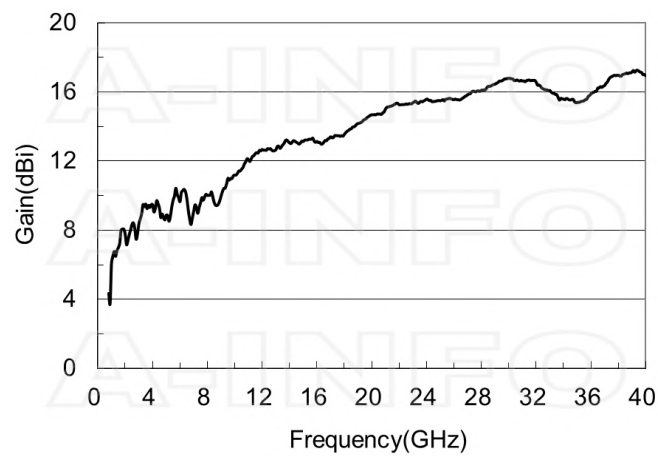

Antenna Factor

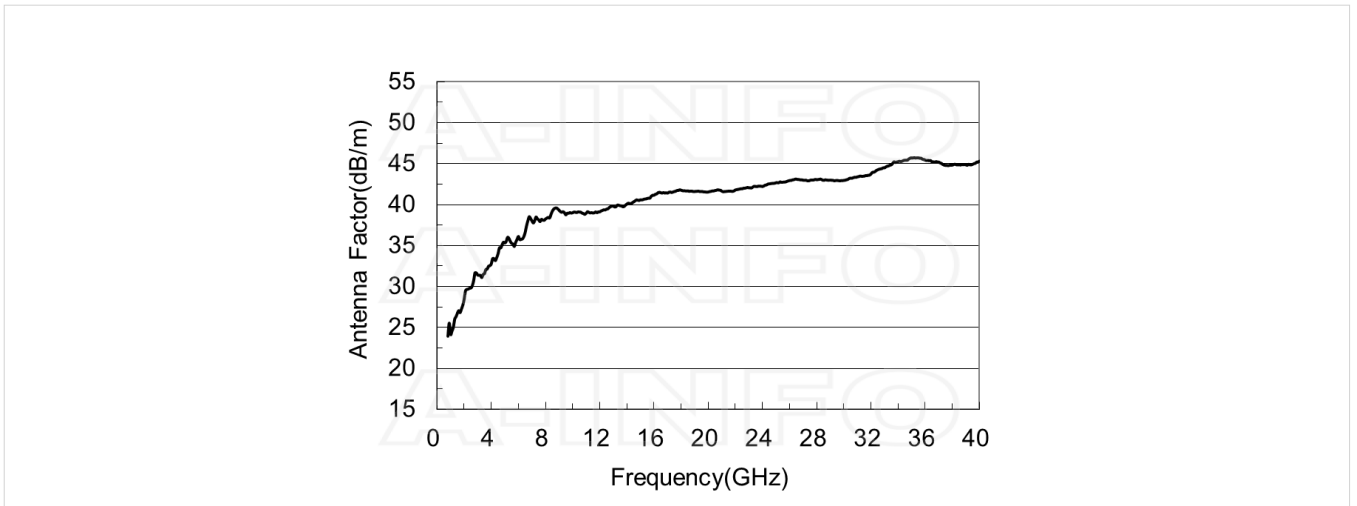

Antenna Factor (Table)

Frequency(GHz)	Gain(dBi)	Antenna Factor(dB/m)
0.8	4.34	23.93
0.9	3.76	25.53
1.0	6.06	24.15
2.0	7.78	28.45
3.0	8.35	31.40
4.0	9.48	32.77
5.0	8.87	35.32
6.0	9.66	36.12
7.0	9.08	38.03
8.0	10.02	38.26
9.0	9.98	39.32
10.0	11.20	39.01
12.0	12.68	39.12
14.0	13.06	40.08
16.0	13.14	41.15
18.0	13.55	41.76
20.0	14.68	41.55
22.0	15.26	41.80
24.0	15.59	42.22
26.0	15.56	42.95
28.0	16.11	43.05
30.0	16.79	42.97
32.0	16.57	43.74
34.0	15.59	45.25
36.0	15.89	45.45
38.0	16.98	44.83
40.0	16.94	45.31

Cross Polarization Isolation

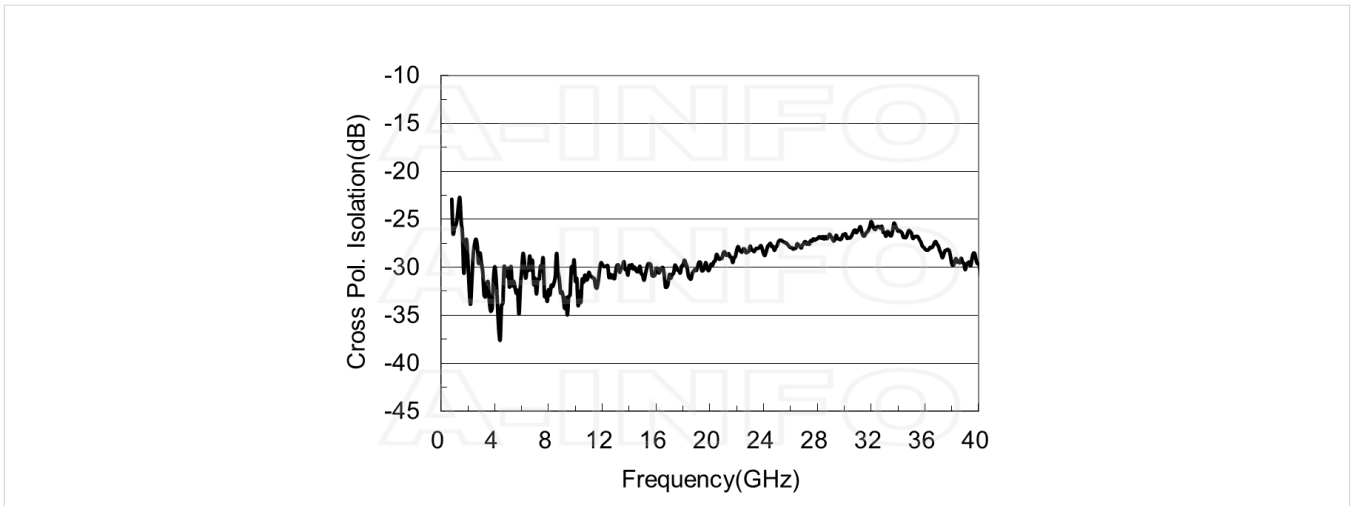

VSWR

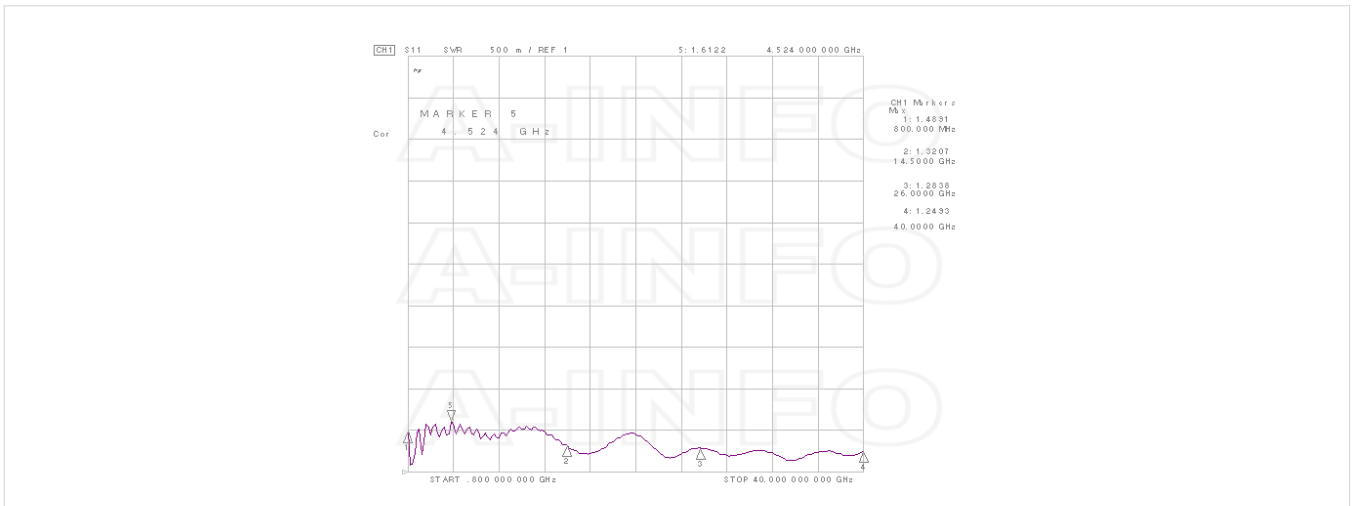

Beamwidth

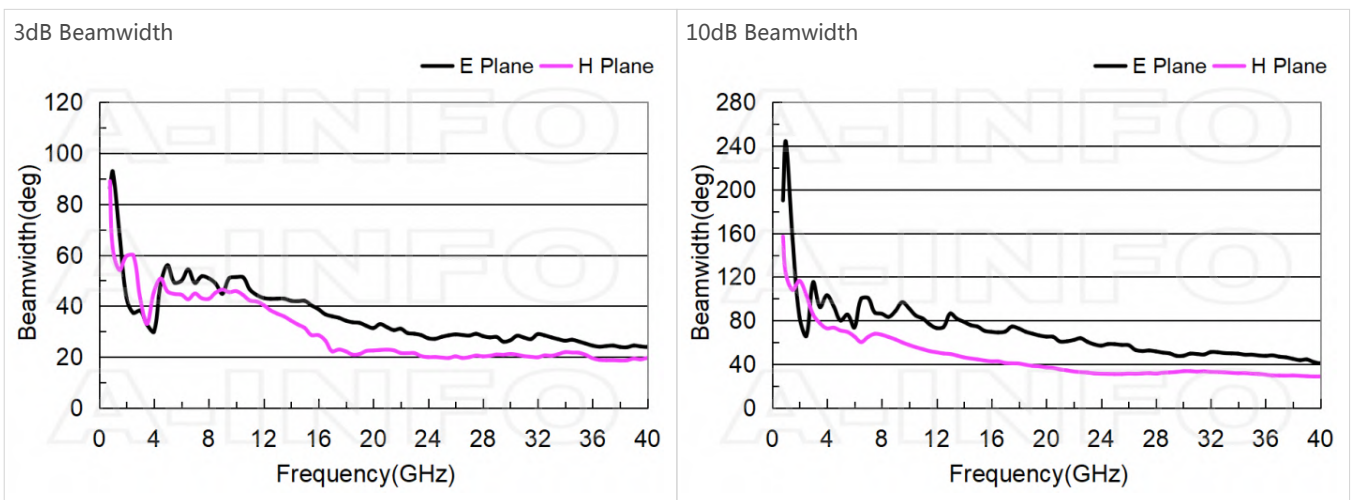

Pattern

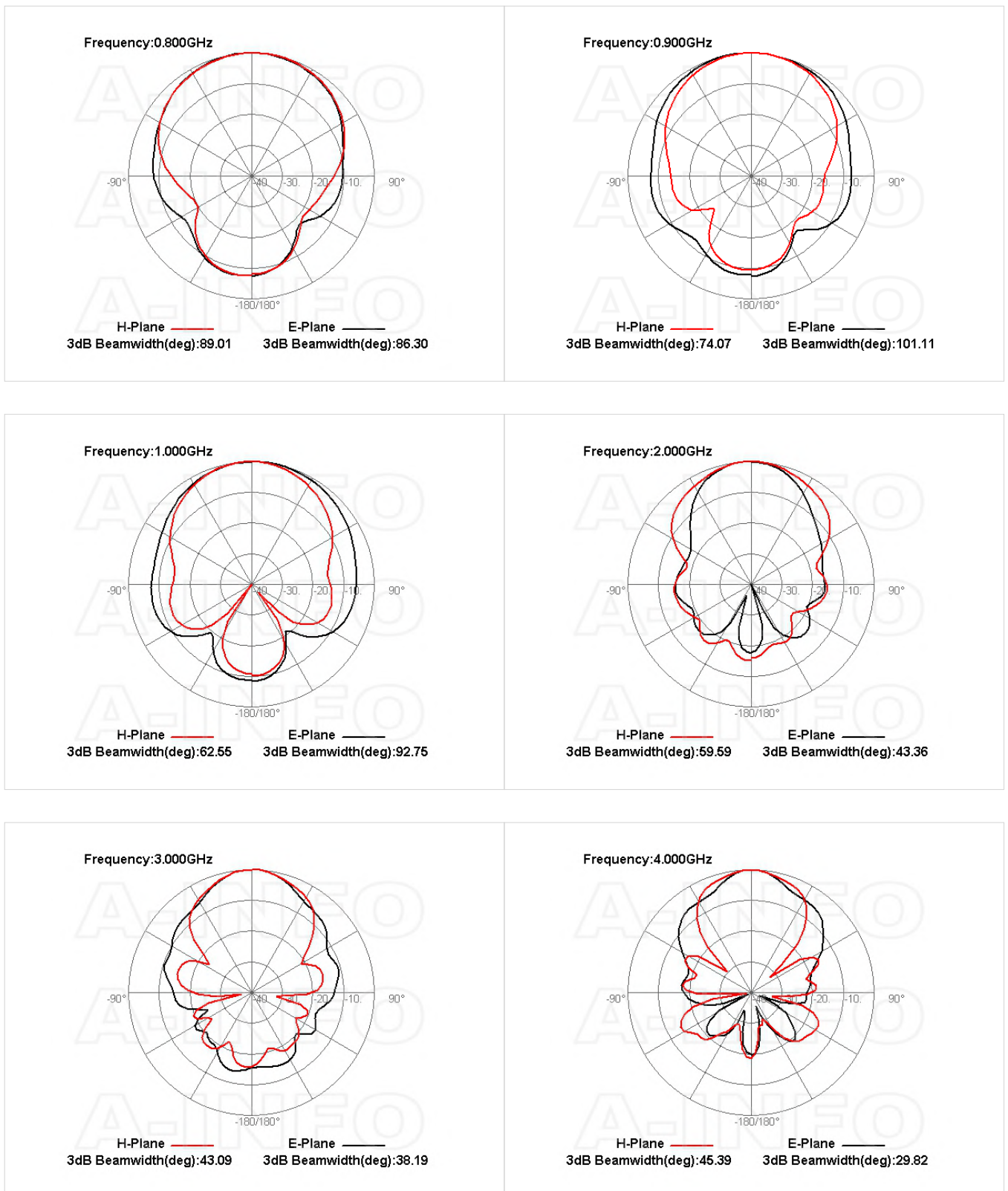

Frequency:5.000GHz

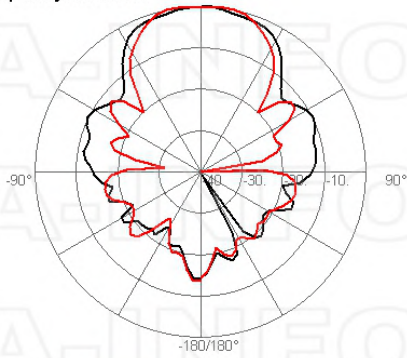

H-Plane 3dB Beamwidth(deg):45.64 E-Plane 3dB Beamwidth(deg):56.01

Frequency:6.000GHz

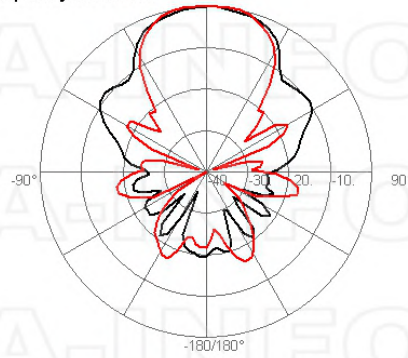

H-Plane 3dB Beamwidth(deg):44.44 E-Plane 3dB Beamwidth(deg):49.84

Frequency:7.000GHz

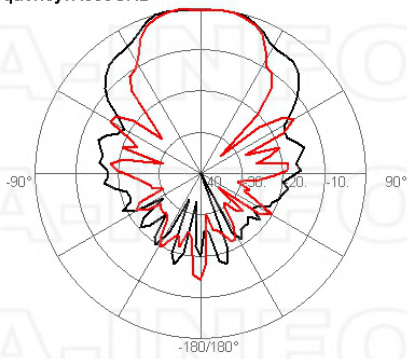

H-Plane 3dB Beamwidth(deg):44.89 E-Plane 3dB Beamwidth(deg):48.99

Frequency:8.000GHz

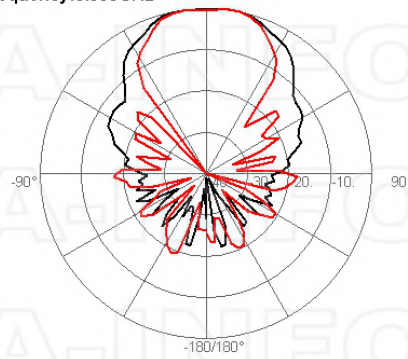

H-Plane 3dB Beamwidth(deg):42.80 E-Plane 3dB Beamwidth(deg):50.87

Frequency:9.000GHz

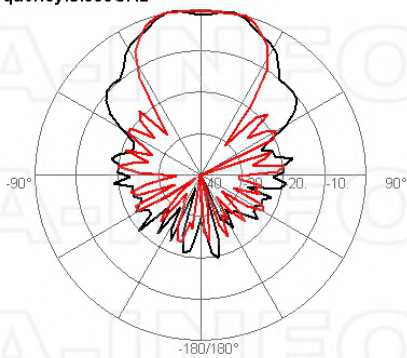

H-Plane 3dB Beamwidth(deg):46.42 E-Plane 3dB Beamwidth(deg):44.79

Frequency:10.000GHz

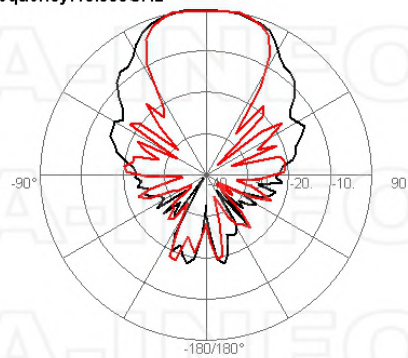

H-Plane 3dB Beamwidth(deg):45.83 E-Plane 3dB Beamwidth(deg):51.34

Frequency:12.000GHz

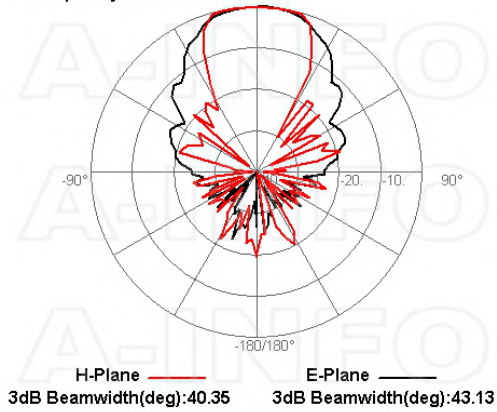

Frequency:14.000GHz

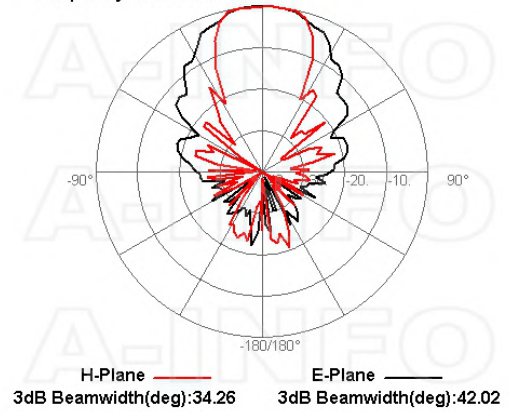

Frequency:16.000GHz

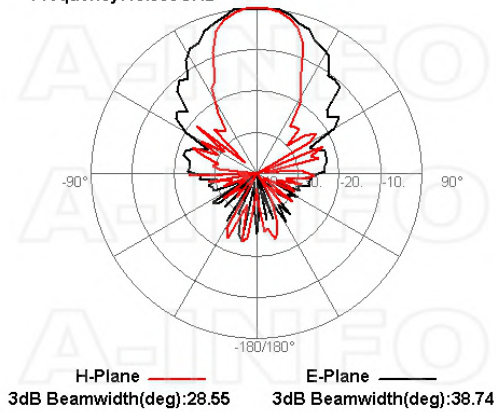

Frequency:18.000GHz

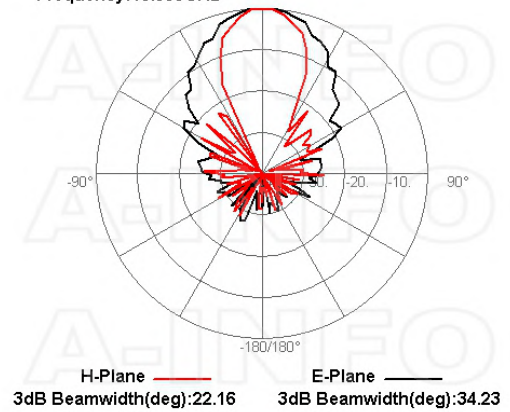

Frequency:20.000GHz

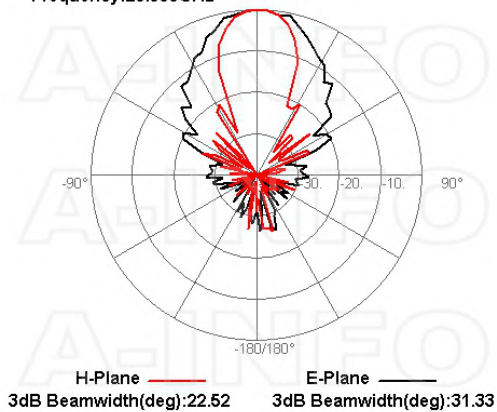

Frequency:22.000GHz

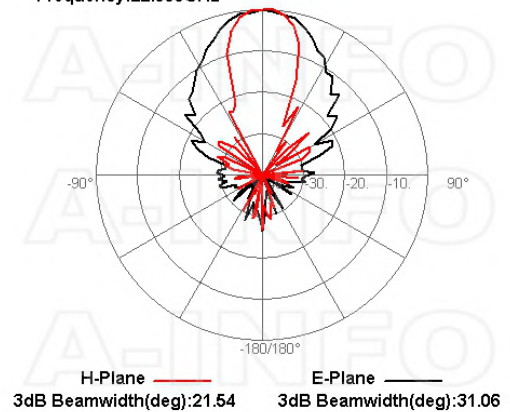

Frequency:24.000GHz

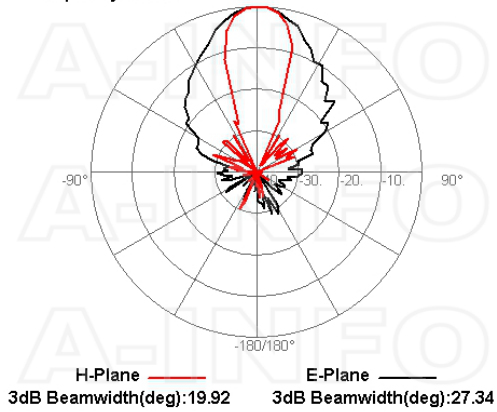

Frequency:26.000GHz

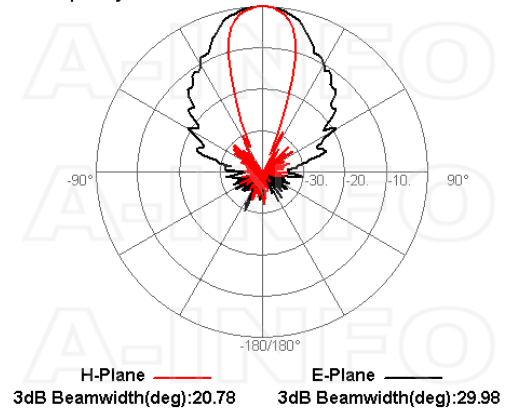

Frequency:28.000GHz

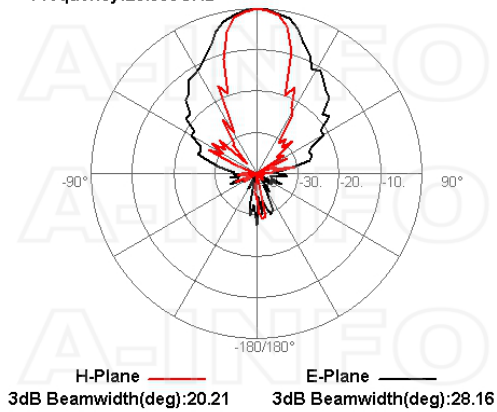

Frequency:30.000GHz

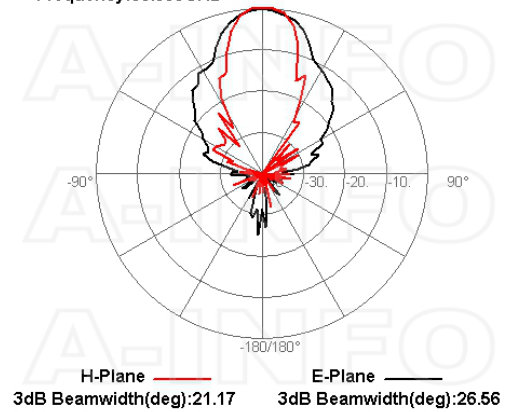

Frequency:32.000GHz

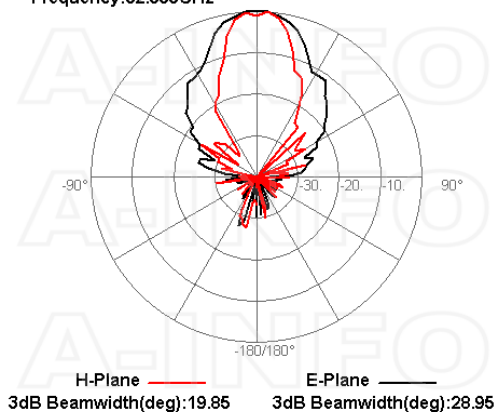

Frequency:34.000GHz

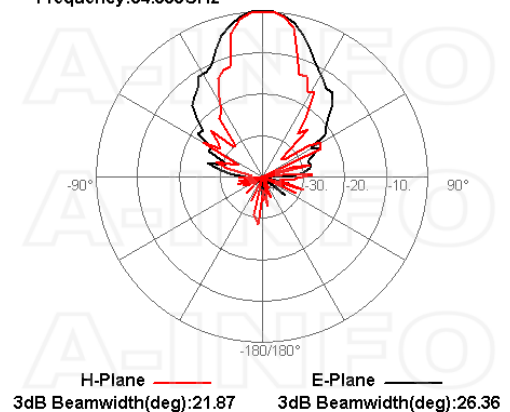

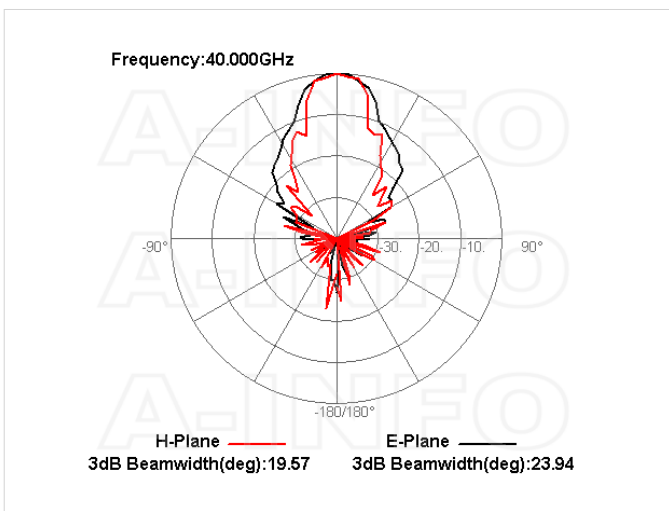
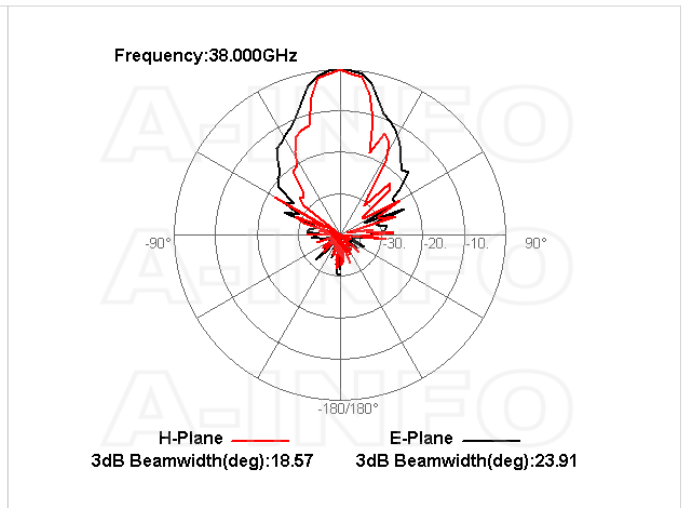
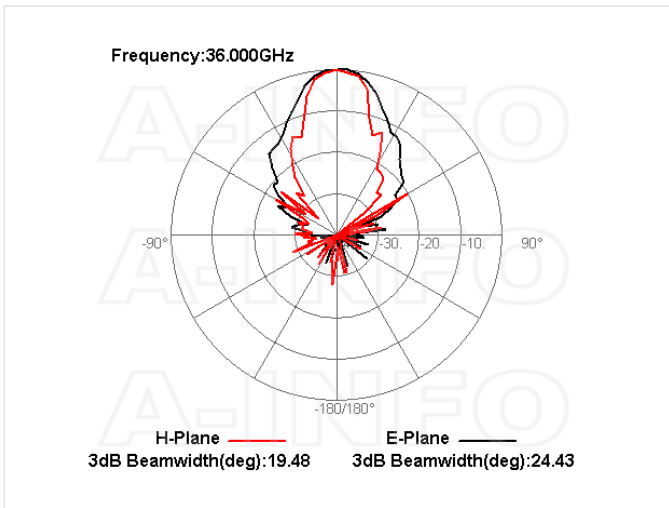

Related Products



LB-20180-L L Type Mounting Bracket



Tripod_15Kg Al Alloy Tripod



3033HL Wooden Tripod



3033QM Wooden Tripod Metalfree



2.92M-2.92M-A050-1000 Flexible Cable Assembly 1000mm DC-40GHz 2.92mm Male to 2.92mm Male



2.92M-2.92M-A050-1500 Flexible Cable Assembly 1500mm DC-40GHz 2.92mm Male to 2.92mm Male



2.92M-2.92M-A050-2000 Flexible Cable Assembly 2000mm DC-40GHz 2.92mm Male to 2.92mm Male



2.92M-2.92M-A050-3000 Flexible Cable Assembly 3000mm DC-40GHz 2.92mm Male to 2.92mm Male



2.92M-2.92M-A050-5000 Flexible Cable Assembly 5000mm DC-40GHz 2.92mm Male to 2.92mm Male



2.92M-2.92M-A050-10000 Flexible Cable Assembly 10000mm DC-40GHz 2.92mm Male to 2.92mm Male

Similar Products



LB-8300-KF Broadband Horn Antenna 0.8-30GHz 12dB Gain 2.92mm Female



LB-8300-2.4F Broadband Horn Antenna 0.8-30GHz 12dB Gain 2.4mm Female



LB-8400-2.4F Broadband Horn Antenna 0.8-40GHz 12dB Gain 2.4mm Female



LB-8440-2.4F Broadband Horn Antenna 0.8-44GHz 12dB Gain 2.4mm Female



LB-8500-2.4F Broadband Horn Antenna 0.8-50GHz 12dB Gain 2.4mm Female



LB-40400-KF Broadband Horn Antenna 4-40GHz 13dB Gain 2.92mm Female



LB-40400-KFSPO Broadband Horn Antenna 4-40GHz 13dB Gain 2.92mm Female



LB-40400-2.4F Broadband Horn Antenna 4-40GHz 13dB Gain 2.4mm Female

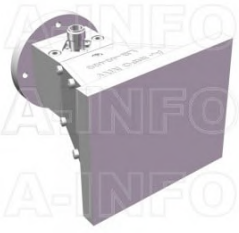

LB-40400-2.4FSPO Broadband Horn Antenna 4-40GHz 13dB Gain 2.4mm Female



LB-45500-2.4F Broadband Horn Antenna 4.5-50GHz 13dB Gain 2.4mm Female

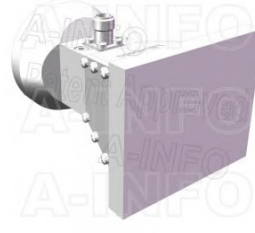

LB-45500-2.4FSPO Broadband Horn Antenna 4.5-50GHz 13dB Gain 2.4mm Female



LB-SJ-40400-KF Broadband Dual Polarization Horn Antenna 4-40GHz 12dB Gain 2.92mm Female



LB-SJ-40400-KFSPO Broadband Dual Polarization Horn Antenna 4-40GHz 12dB Gain 2.92mm Female



LB-SJ-40400-2.4F Broadband Dual Polarization Horn Antenna 4-40GHz 12dB Gain 2.4mm Female



LB-SJ-40400-2.4FSPO Broadband Dual Polarization Horn Antenna 4-40GHz 12dB Gain 2.4mm Female



LB-SJ-50500-2.4F Broadband Dual Polarization Horn Antenna 5-50GHz 12dB Gain 2.4mm Female



LB-SJ-50500-1.85F Broadband Dual Polarization Horn Antenna 5-50GHz 12dB Gain 1.85mm Female

About this Datasheet

<ul style="list-style-type: none"> ● Product Information Product Link: https://www.ainfoinc.com/lb-8400-kf-broadband-horn-antenna-0-8-40-ghz-12db-gain-2-92mm-female Data subject to change without notice. © A-INFO INC. 2024. All Rights Reserved 	<ul style="list-style-type: none"> ● Contact Us Address: 60 Tesla, Irvine, CA 92618, USA Website: www.ainfoinc.com Email: sales@ainfoinc.com 	<ul style="list-style-type: none"> ● Phone & Fax Phone: +1-949-639-9688 +1-949-639-9608 Fax: +1-949-639-9670
---	--	---