

LB-20200-NFP Broadband Horn Antenna 2-20GHz 12dB Gain N Type Female



Broadband Horn Antenna Operating From 2GHz to 20GHz With a Nominal 12dB Gain With N Type Female Connector

Product Information

| | |
|-----|--------------|
| SKU | LB-20200-NFP |
|-----|--------------|

Description

Broadband horn antenna LB-20200-NFP, operating from 2 to 20GHz with a nominal 12dB gain and low VSWR 1.5:1 with N Type Female output connector. The model LB-20200-NFP has uniform gain through its frequency span, providing efficient performance characteristics and directionality. It can handle 150W continuously and 300W peak power. Constructed of lightweight corrosion-resistant aluminum, the antenna will provide years of trouble-free indoor and outdoor service. This broadband horn antenna is linearly polarized and ideally suited for EMI testing, direction finding, surveillance, antenna gain and pattern measurements and other applications.

Also we provide specific gain horn antennas according to customers' requirement.

Technical Specification

| Electrical Specification | | Interface | |
|------------------------------------|--------|--------------------------|-----------------------------|
| Frequency, Min (GHz) | 2 | Output Type | Coaxial |
| Frequency, Max (GHz) | 20 | Connector | N Type |
| Gain, Typ (dBi) | 12 | Connector Gender | Female |
| Polarization | Linear | Mechanical Specification | |
| 3dB Beamwidth, E-Plane, Min (Deg.) | 16 | Body Material | Al |
| 3dB Beamwidth, E-Plane, Max (Deg.) | 85 | Finish | Chemical Conversion Coating |
| 3dB Beamwidth, H-Plane, Min (Deg.) | 18 | Size, W (mm) | 103.8 |
| 3dB Beamwidth, H-Plane, Max (Deg.) | 77 | Size, H (mm) | 77.9 |
| Cross Pol. Isolation, Typ (dB) | 25 | Size, L (mm) | 127 |
| VSWR, Typ | 1.5:1 | Weight, (kg) | 0.4 |
| Impedance, (Ohm) | 50 | | |
| Power Handling, CW, (W) | 150 | | |
| Power Handling, Peak, (W) | 300 | | |

Additional Information

| | | | |
|-------------|---|--------------|---|
| Application | General Purpose Indoor & Outdoor, Fixed | Solution for | Gain Reference Antenna Measurement Reflector Feed Far-field Measurement System Intergration |
|-------------|---|--------------|---|

Outline Drawing

N-Female Output with Side Plate (Option, P/N: LB-20200-NFP)

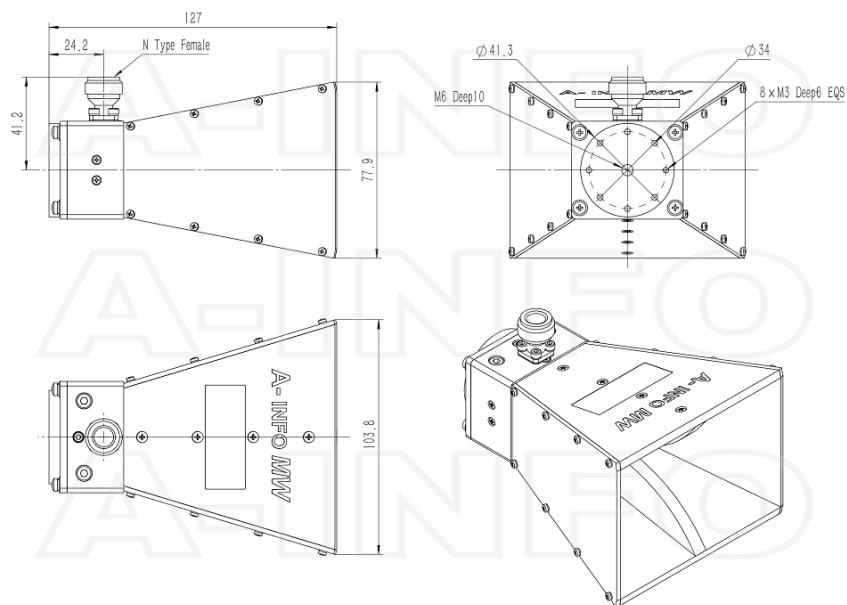

Typical Test Results

Gain

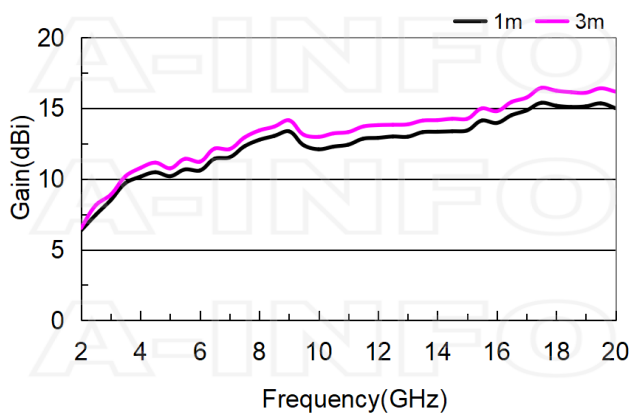

Antenna Factor

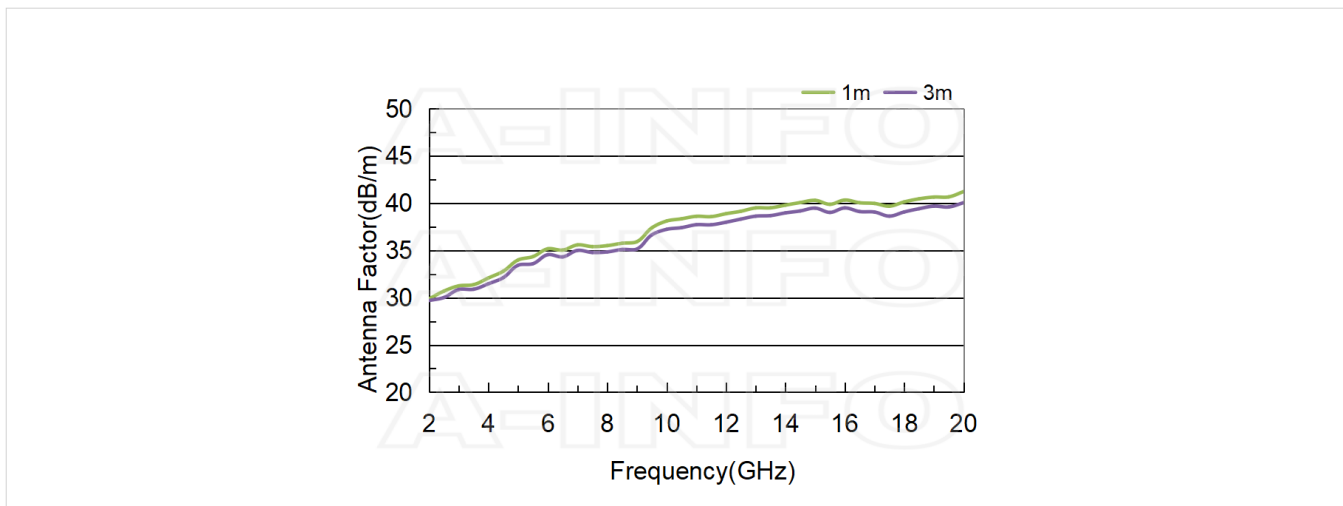

Antenna Factor (Table)

| Frequency(GHz) | 1m | | 3m | |
|-----------------|------------|----------|------------|----------|
| | Gain(dBi) | AF(dB/m) | Gain(dBi) | AF(dB/m) |
| 2.0 | 6.36 | 29.87 | 6.53 | 29.70 |
| 3.0 | 8.50 | 31.25 | 8.89 | 30.86 |
| 4.0 | 10.16 | 32.09 | 10.78 | 31.47 |
| 5.0 | 10.20 | 33.99 | 10.75 | 33.44 |
| 6.0 | 10.60 | 35.17 | 11.22 | 34.55 |
| 7.0 | 11.53 | 35.59 | 12.11 | 35.00 |
| 8.0 | 12.76 | 35.51 | 13.43 | 34.84 |
| 9.0 | 13.37 | 35.92 | 14.15 | 35.15 |
| 10.0 | 12.10 | 38.11 | 12.98 | 37.23 |
| 12.0 | 12.91 | 38.89 | 13.81 | 37.99 |
| 14.0 | 13.34 | 39.79 | 14.16 | 38.97 |
| 16.0 | 13.96 | 40.33 | 14.79 | 39.50 |
| 18.0 | 15.18 | 40.14 | 16.24 | 39.07 |
| 20.0 | 15.00 | 41.23 | 16.18 | 40.05 |

Field Strength

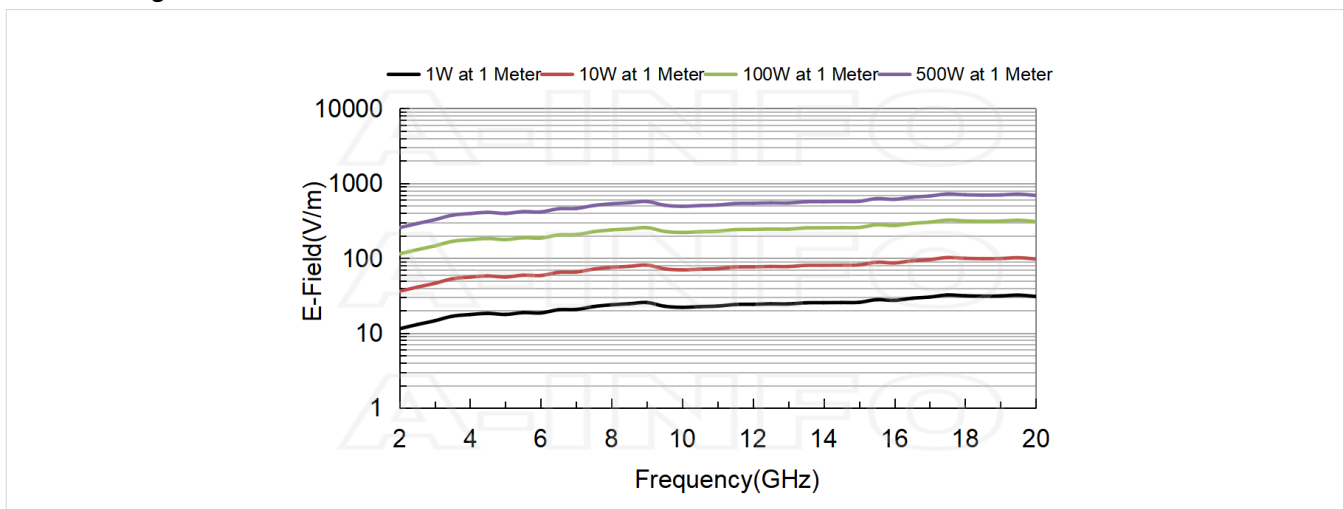

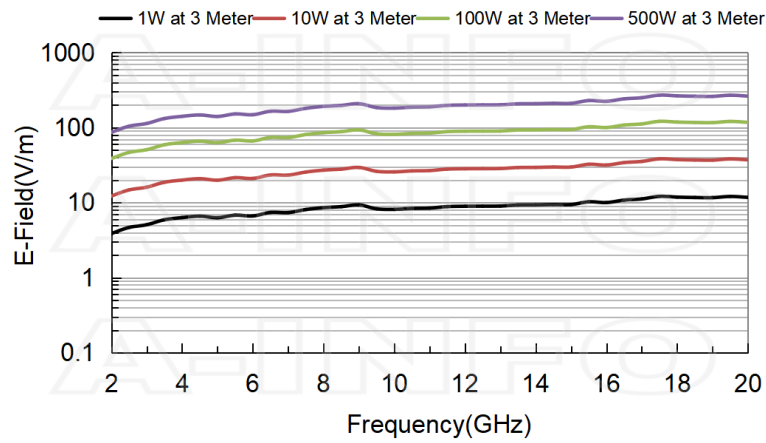

Cross Polarization Isolation

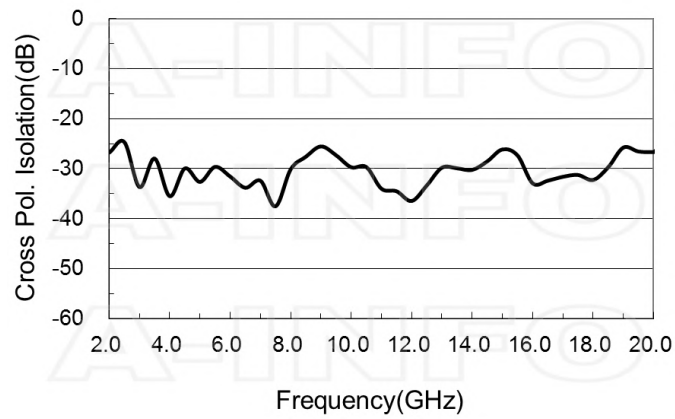

VSWR

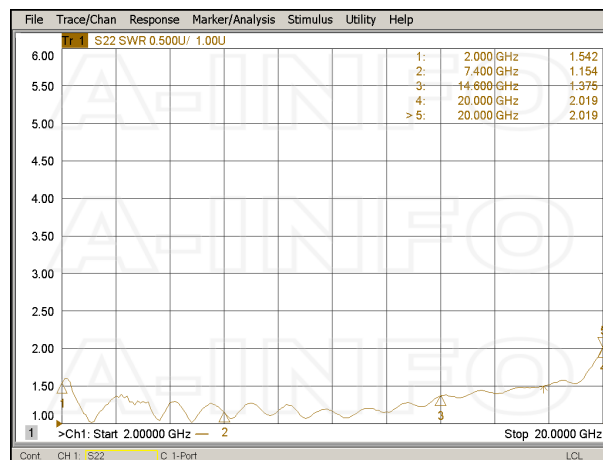

Beamwidth

3dB Beamwidth

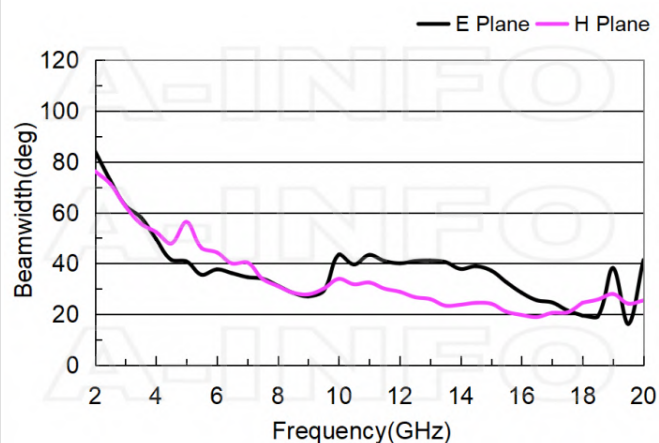

10dB Beamwidth

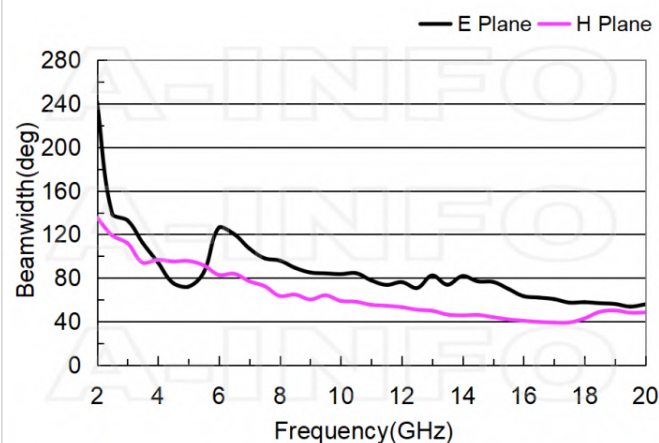

Pattern

Frequency:2.000GHz

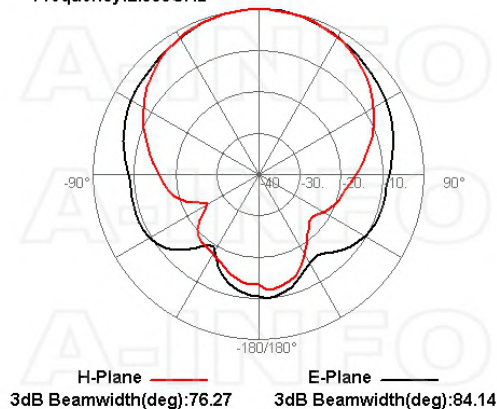

Frequency:3.000GHz

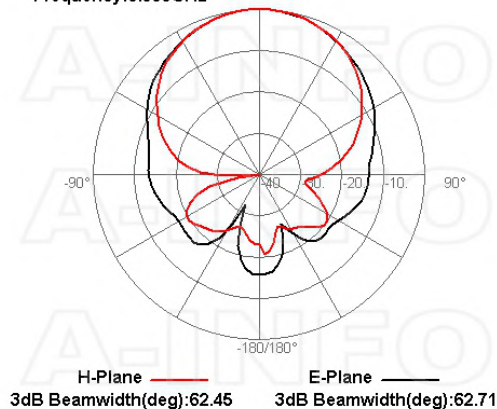

Frequency:4.000GHz

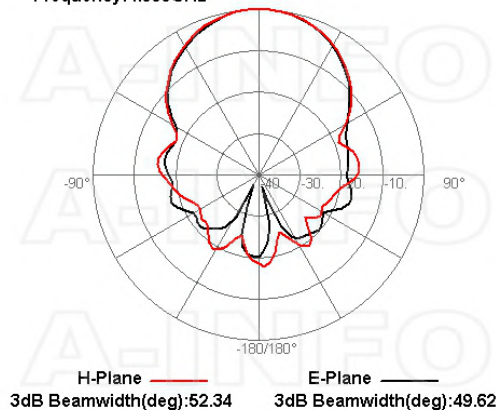

Frequency:5.000GHz

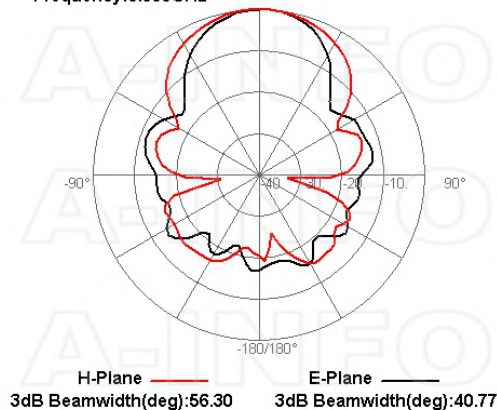

Frequency:6.000GHz

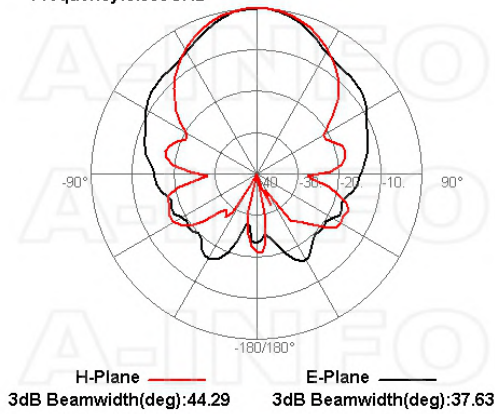

Frequency:7.000GHz

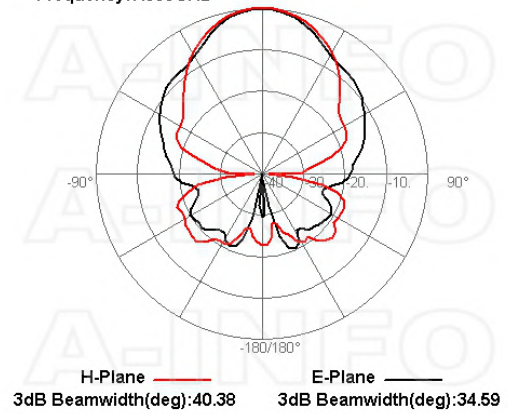

Frequency:8.000GHz

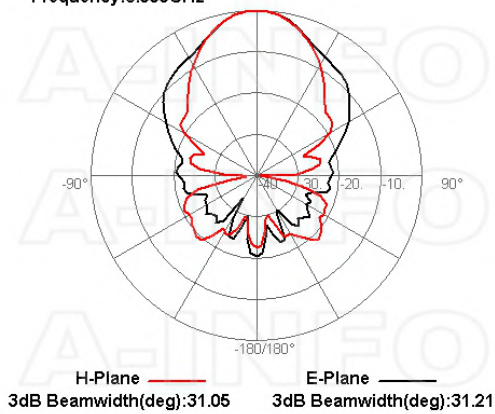

Frequency:9.000GHz

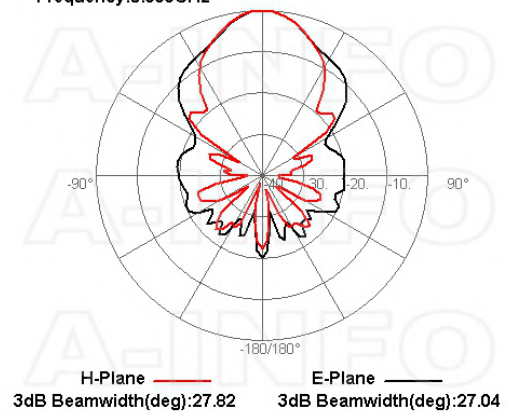

Frequency:10.000GHz

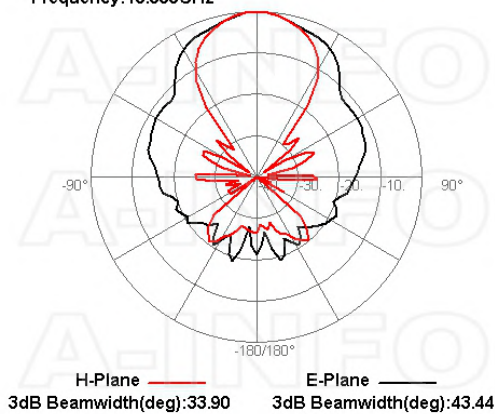

Frequency:12.000GHz

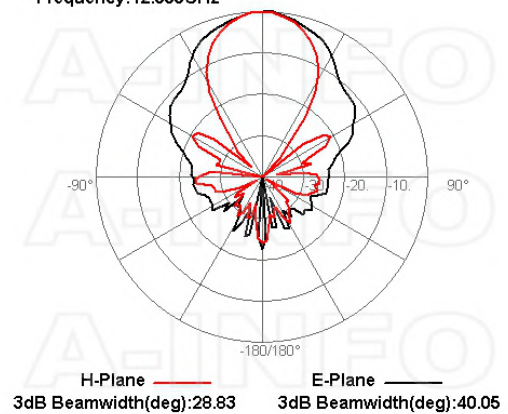

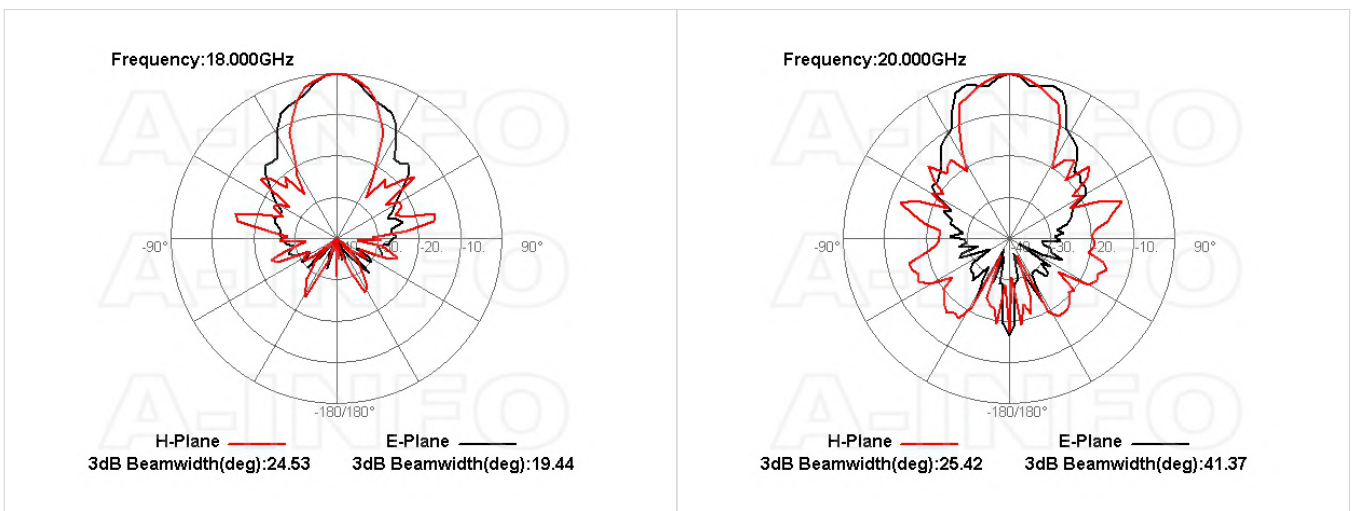
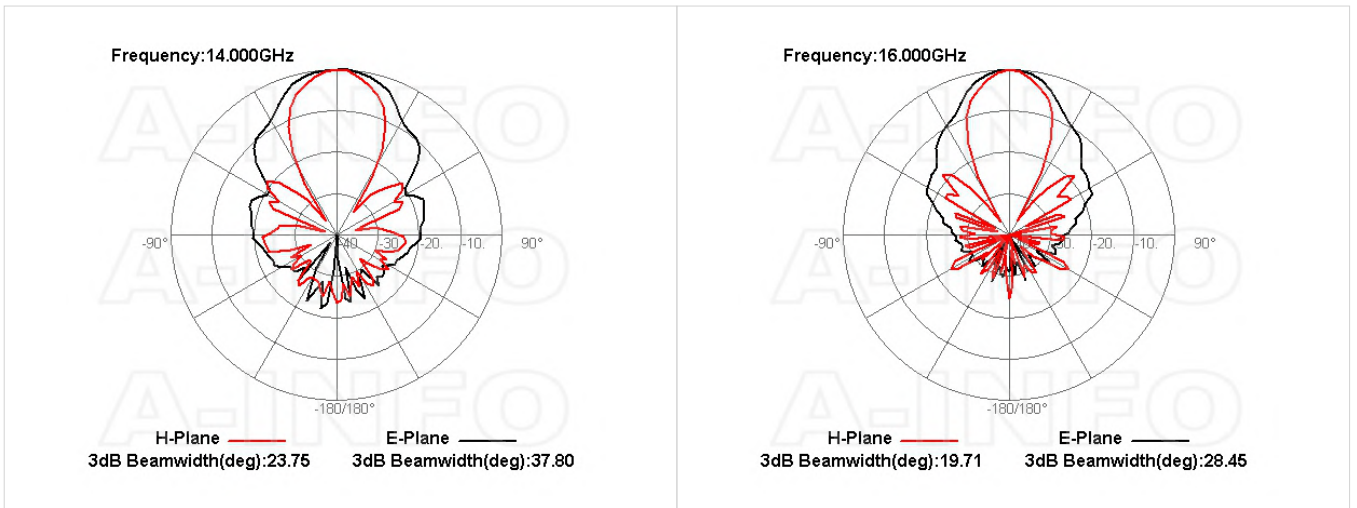

Related Products



LB-20180-L L Type Mounting Bracket



Tripod_15Kg Al Alloy Tripod



3033HL Wooden Tripod



3033QM Wooden Tripod Metalfree



Carrying Case_LB-20180 AI Alloy Carrying Case



NM-NM-A050-500 Flexible Cable Assembly 500mm DC- 18GHz N Male to N Male



NM-NM-A050-1000 Flexible Cable Assembly 1000mm DC- 18GHz N Male to N Male



NM-NM-A050-1500 Flexible Cable Assembly 1500mm DC- 18GHz N Male to N Male



NM-NM-A050-2000 Flexible Cable Assembly 2000mm DC- 18GHz N Male to N Male



NM-NM-A050-3000 Flexible Cable Assembly 3000mm DC- 18GHz N Male to N Male



NM-NM-A050-5000 Flexible Cable Assembly 5000mm DC- 18GHz N Male to N Male



NM-NM-A050-10000 Flexible Cable Assembly 10000mm DC- 18GHz N Male to N Male



NM-NM-A050-20000 Flexible Cable Assembly 20000mm DC- 18GHz N Male to N Male



NM-NM-A100-500 Flexible Cable Assembly 500mm DC- 18GHz N Male to N Male



NM-NM-A100-1000 Flexible Cable Assembly 1000mm DC- 18GHz N Male to N Male



NM-NM-A100-1500 Flexible Cable Assembly 1500mm DC- 18GHz N Male to N Male



NM-NM-A100-2000 Flexible Cable Assembly 2000mm DC- 18GHz N Male to N Male



NM-NM-A100-3000 Flexible Cable Assembly 3000mm DC- 18GHz N Male to N Male



NM-NM-A100-5000 Flexible Cable Assembly 5000mm DC- 18GHz N Male to N Male



NM-NM-A100-10000 Flexible Cable Assembly 10000mm DC- 18GHz N Male to N Male



NM-NM-A100-20000 Flexible Cable Assembly 20000mm DC-18GHz N Male to N Male

Similar Products



LB-2080-SF Broadband Horn Antenna 2-8GHz 12dB Gain SMA Female



LB-2080-SFP Broadband Horn Antenna 2-8GHz 12dB Gain SMA Female



LB-2080-SFSP0 Broadband Horn Antenna 2-8GHz 12dB Gain SMA Female



LB-2080-NF Broadband Horn Antenna 2-8GHz 12dB Gain N Type Female



LB-2080-NFP Broadband Horn Antenna 2-8GHz 12dB Gain N Type Female



LB-2080-NFSP0 Broadband Horn Antenna 2-8GHz 12dB Gain N Type Female



LB-20180-SF Broadband Horn Antenna 2-18GHz 12dB Gain SMA Female



LB-20180-SFP Broadband Horn Antenna 2-18GHz 12dB Gain SMA Female



LB-20180-SFSP0 Broadband Horn Antenna 2-18GHz 12dB Gain SMA Female



LB-20180-NF Broadband Horn Antenna 2-18GHz 12dB Gain N Type Female



LB-20180-NFP Broadband Horn Antenna 2-18GHz 12dB Gain N Type Female



LB-20180-NFSP0 Broadband Horn Antenna 2-18GHz 12dB Gain N Type Female



LB-20180-NFSPS Broadband Horn Antenna 2-18GHz 12dB Gain N Type Female



LB-20180H-SF Broadband Horn Antenna 2-18GHz 17dB Gain SMA Female



LB-20180H-SFSPS Broadband Horn Antenna 2-18GHz 17dB Gain SMA Female



LB-20180H-SFSPS Broadband Horn Antenna 2-18GHz 17dB Gain SMA Female



LB-20180H-NF Broadband Horn Antenna 2-18GHz 17dB Gain N Type Female



LB-20180H-NFSPS Broadband Horn Antenna 2-18GHz 17dB Gain N Type Female



LB-20200-SF Broadband Horn Antenna 2-20GHz 12dB Gain SMA Female



LB-20200-SFP Broadband Horn Antenna 2-20GHz 12dB Gain SMA Female



LB-20200-SFSPS Broadband Horn Antenna 2-20GHz 12dB Gain SMA Female



LB-20200-NF Broadband Horn Antenna 2-20GHz 12dB Gain N Type Female



LB-20200-NFSPS Broadband Horn Antenna 2-20GHz 12dB Gain N Type Female



LB-20200-NFSPS Broadband Horn Antenna 2-20GHz 12dB Gain N Type Female



LB-20200H-SF Broadband Horn Antenna 2-20GHz 17dB Gain SMA Female



LB-20200H-SFSPS Broadband Horn Antenna 2-20GHz 17dB Gain SMA Female



LB-20200H-NF Broadband Horn Antenna 2-20GHz 17dB Gain N Type Female



LB-20200H-NFSPS Broadband Horn Antenna 2-20GHz 17dB Gain N Type Female



LB-SJ-20180-SF Broadband Dual Polarization Horn Antenna
2-18GHz 14dB Gain SMA Female



LB-SJ-20180-SFSP0 Broadband Dual Polarization Horn Antenna
2-18GHz 14dB Gain SMA Female

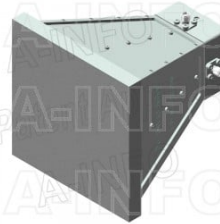

LB-SJ-20180-SFSPS Broadband Dual Polarization Horn Antenna
2-18GHz 14dB Gain SMA Female



LB-SJ-20180-NF Broadband Dual Polarization Horn Antenna
2-18GHz 14dB Gain N Type Female



LB-SJ-20180-NFSP0 Broadband Dual Polarization Horn Antenna
2-18GHz 14dB Gain N Type Female



LB-OSJ-20180-SF Open Boundary Quad-Ridged Dual Polarization Horn Antenna
2-18GHz 13dB Gain SMA Female

About this Datasheet

| | | |
|---|--|---|
| <ul style="list-style-type: none"> ● Product Information Product Link: https://www.ainfoinc.com/lb-20200-nfp-broadband-horn-antenna-2-20-ghz-12db-gain-n-type-female Data subject to change without notice. © A-INFO INC. 2024. All Rights Reserved | <ul style="list-style-type: none"> ● Contact Us Address: 60 Tesla, Irvine, CA 92618, USA Website: www.ainfoinc.com Email: sales@ainfoinc.com | <ul style="list-style-type: none"> ● Phone & Fax Phone: +1-949-639-9688 +1-949-639-9608 Fax: +1-949-639-9670 |
|---|--|---|