



LB-SJ-180500L-2.4F Broadband Dual Polarization Horn Antenna
18-50GHz 8dB Gain 2.4mm Female

Broadband Dual Polarization Horn Antenna Operating From 18GHz to 50GHz With a Nominal 8dB Gain With 2.4mm Female Connector

Product Information

SKU	LB-SJ-180500L-2.4F	Patents	US D1006799 (USA)
-----	--------------------	---------	-------------------

Description

Broadband Dual Polarization Horn Antenna LB-SJ-180500L-2.4F, operating from 18 to 50GHz with a nominal 8dB gain and 2.4mm Female output connector. The model LB-SJ-180500L-2.4F has uniform gain through its frequency span, providing efficient performance characteristics and directionality. It can handle 10W continuously and 20W peak power. Constructed of lightweight corrosion-resistant aluminum, the antenna will provide years of trouble-free indoor and outdoor service. This horn antenna has dual linear polarization and ideally suited for EMI testing, direction finding, surveillance, antenna gain and pattern measurements and other applications.

Technical Specification

Electrical Specification		Interface	
Frequency, Min (GHz)	18	Output Type	Coaxial
Frequency, Max (GHz)	50	Connector	2.4mm
Gain, Typ (dBi)	8	Connector Gender	Female
Polarization	Dual Linear	Mechanical Specification	
3dB Beamwidth, E-Plane, Min (Deg.)	30	Body Material	Al
3dB Beamwidth, E-Plane, Max (Deg.)	85	Finish	Gold Plated, Gray Paint
3dB Beamwidth, H-Plane, Min (Deg.)	42	Size, W (mm)	30.2
3dB Beamwidth, H-Plane, Max (Deg.)	76	Size, H (mm)	30.2
Cross Pol. Isolation, Min (dB)	20	Size, L (mm)	61.5
Cross Pol. Isolation, Typ (dB)	30	Weight, (kg)	0.08
Port to Port Isolation, Min (dB)	25		
Port to Port Isolation, Typ (dB)	35		
VSWR, Typ	2.0:1		
Impedance, (Ohm)	50		
Power Handling, CW, (W)	10		
Power Handling, Peak, (W)	20		

Additional Information

Solution for	Antenna Measurement Reflector Feed Far-field Measurement Planar Near-Field Measurement Cylindrical Near-Field Measurement Spherical Near-Field Measurement CATR System Intergration
--------------	--

Outline Drawing

2.4mm-Female Output (P/N: LB-SJ-180500L-2.4F)

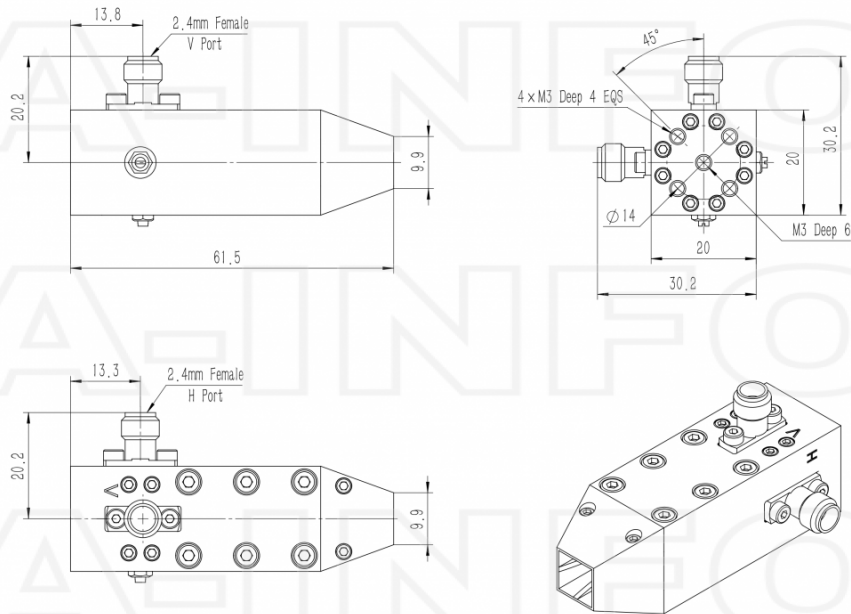

2.4mm-Female Output with L Type Mounting Bracket (Option, P/N: LB-SJ-180400-L)

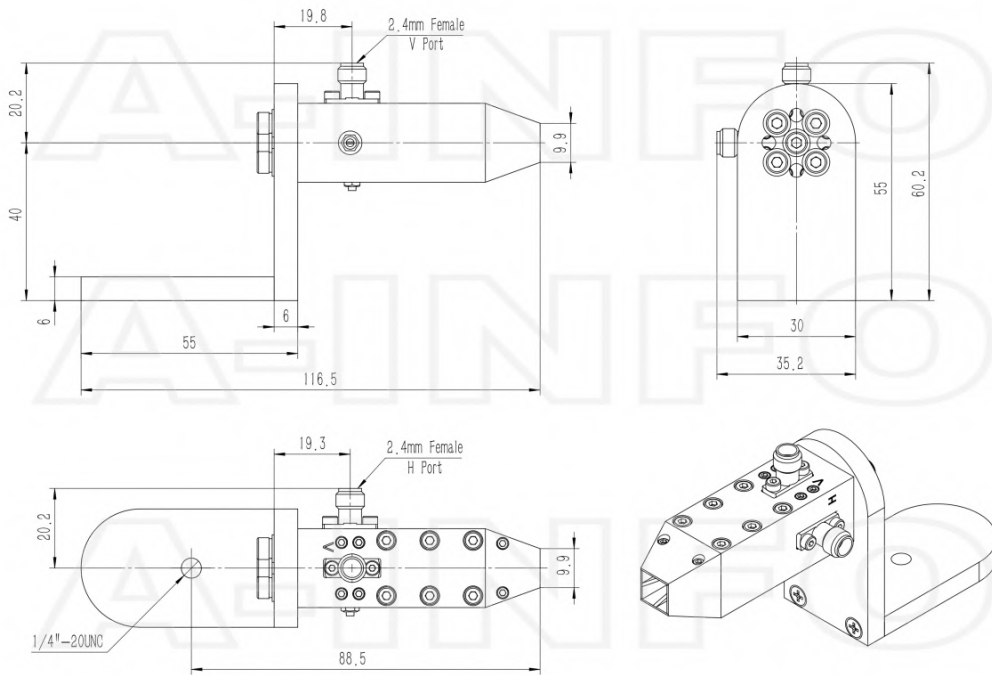

Typical Test Results

Gain

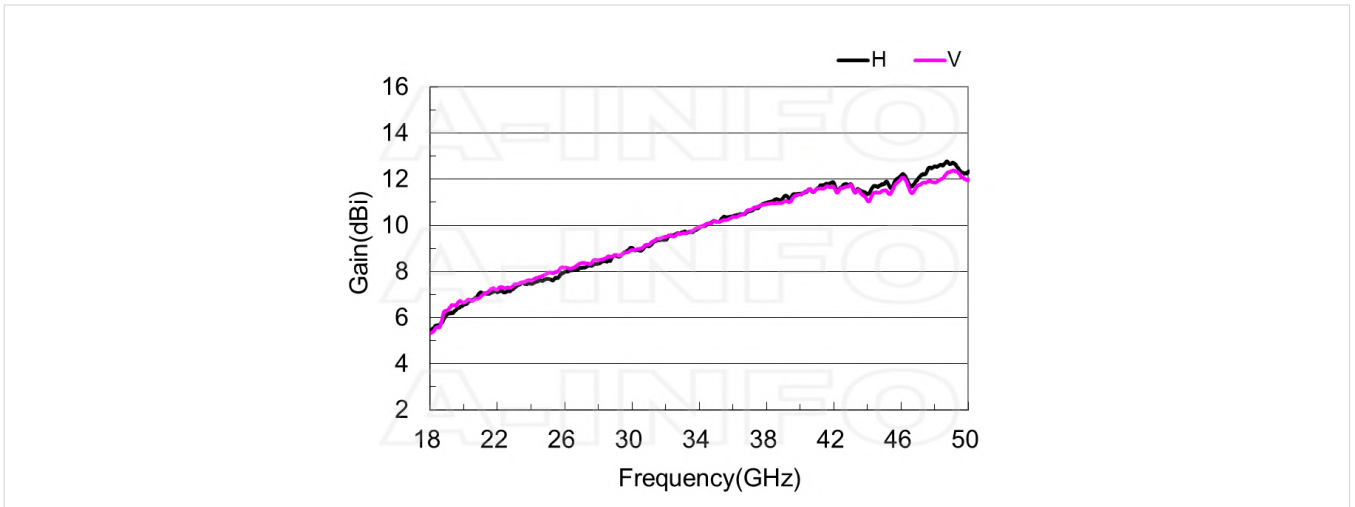

Antenna Factor

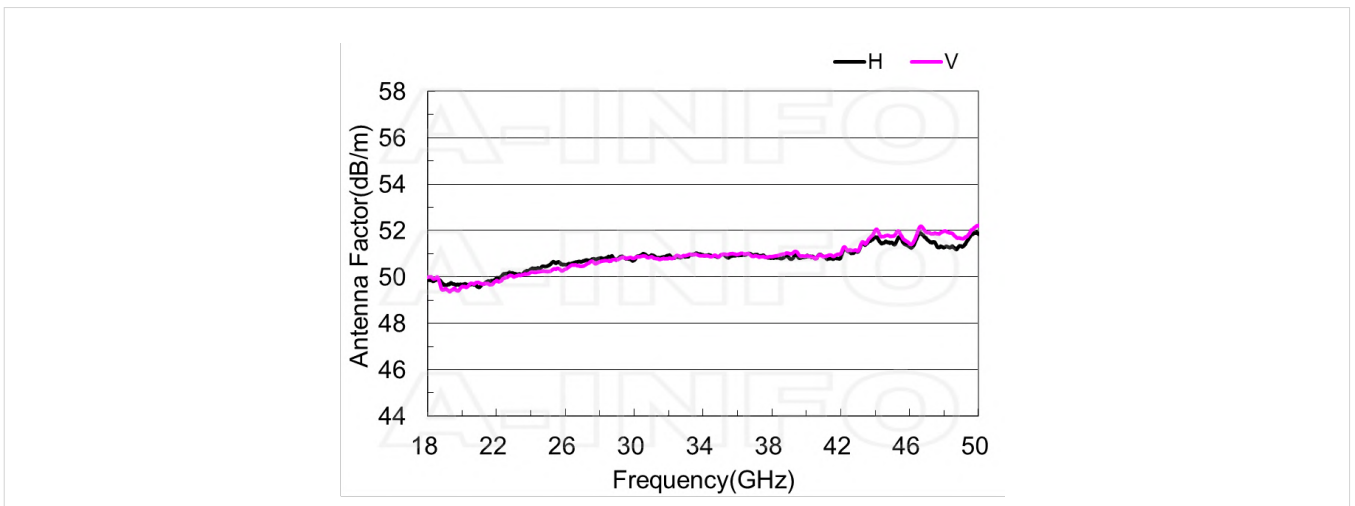

Antenna Factor (Table)

Frequency(GHz)	Horizontal		Vertical	
	Gain(dBi)	AF(dB/m)	Gain(dBi)	AF(dB/m)
18.0	5.44	49.88	5.32	49.99
20.0	6.56	49.68	6.64	49.59
22.0	7.10	49.96	7.22	49.84
24.0	7.47	50.34	7.61	50.20
26.0	7.98	50.53	8.17	50.33
28.0	8.35	50.80	8.50	50.65
30.0	9.03	50.72	8.94	50.81
32.0	9.39	50.93	9.51	50.80
34.0	9.89	50.95	9.93	50.91
36.0	10.39	50.94	10.37	50.97
38.0	10.98	50.83	10.93	50.87
40.0	11.38	50.87	11.35	50.90
42.0	11.84	50.83	11.67	51.01
44.0	11.35	51.73	11.06	52.01
46.0	12.17	51.29	12.04	51.42
48.0	12.56	51.27	11.87	51.97
50.0	12.34	51.84	11.99	52.20

Cross Polarization Isolation

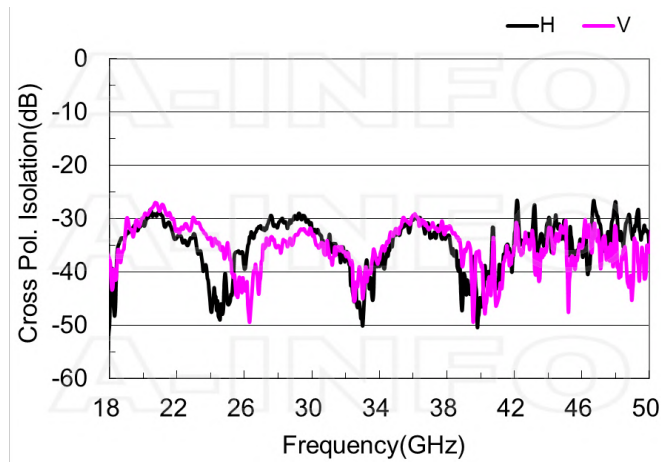

Port to Port Isolation

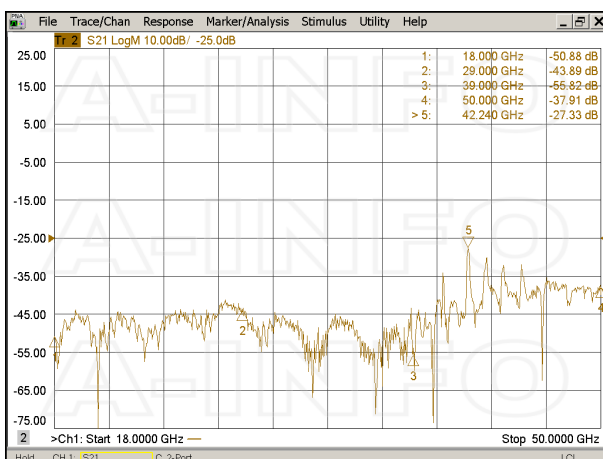

VSWR

Port-H

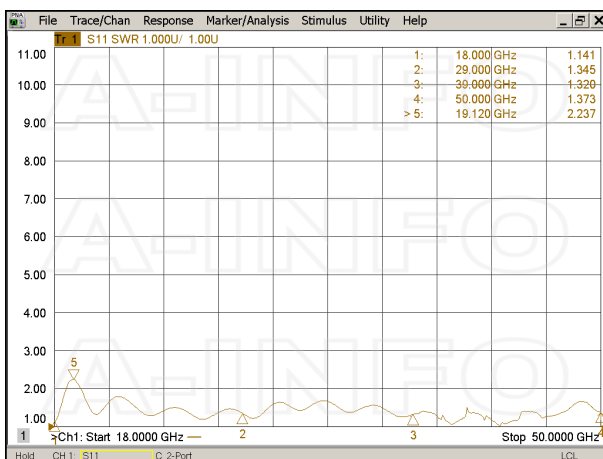

Port-V

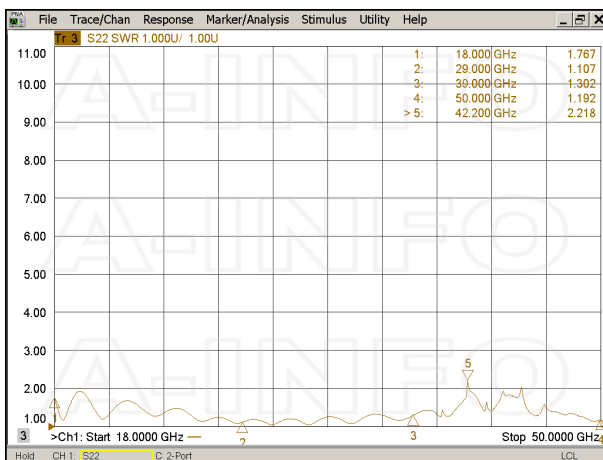

Beamwidth

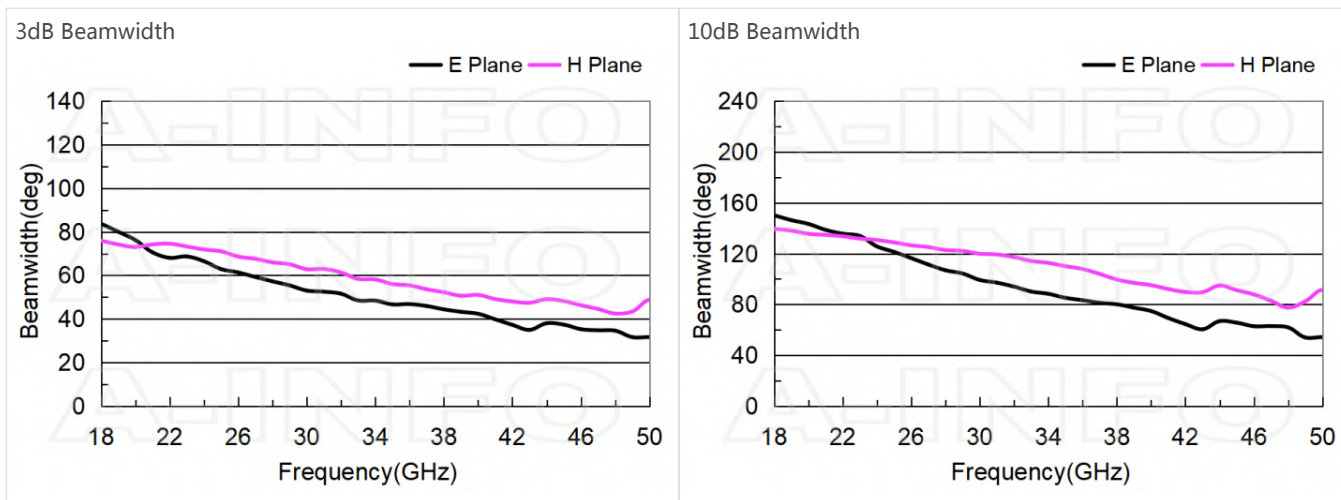

Pattern 1

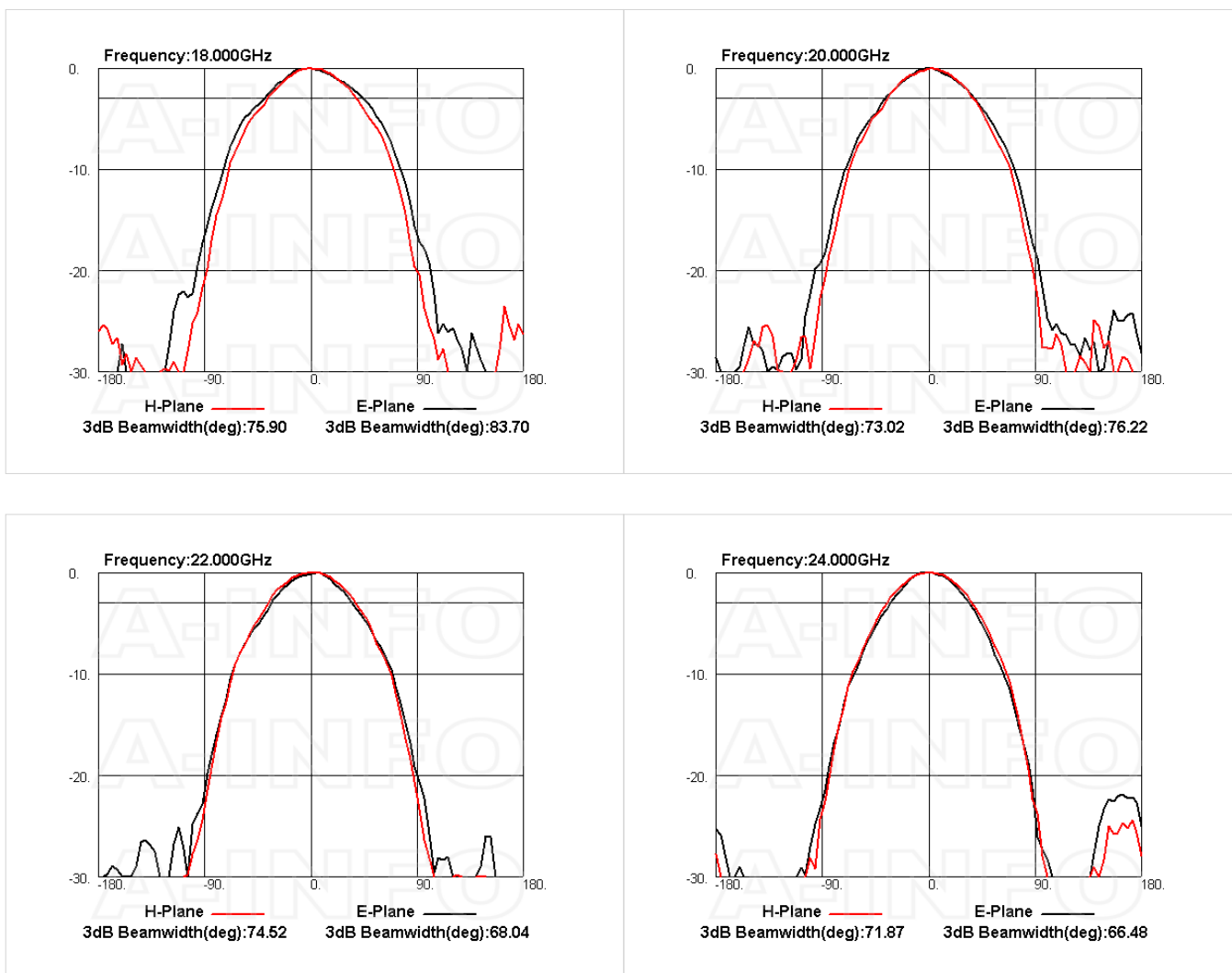

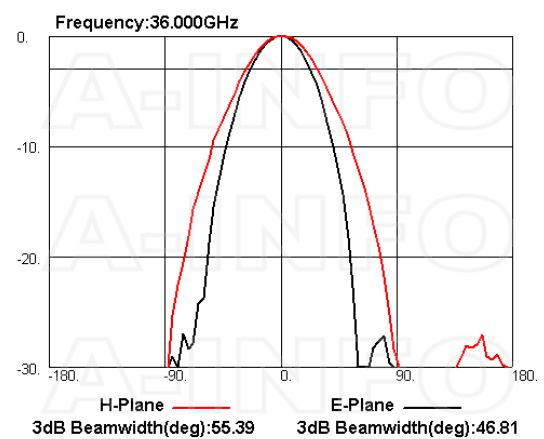
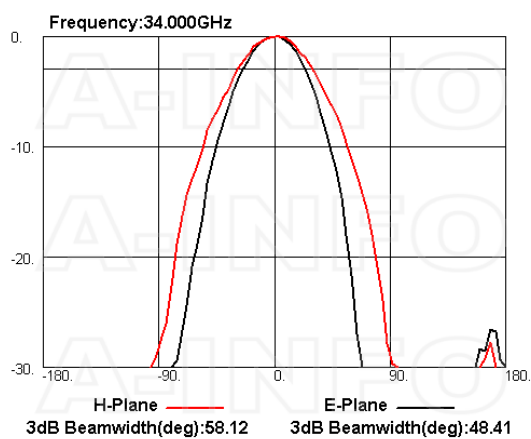
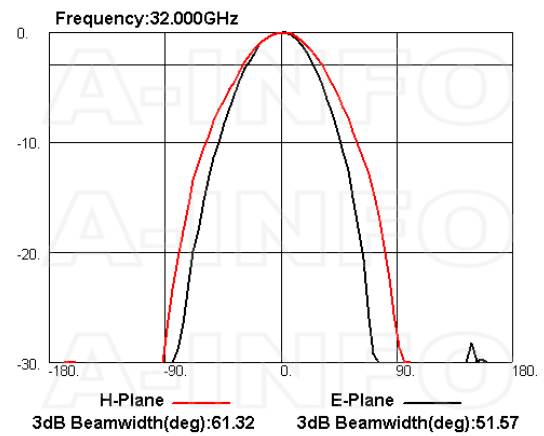
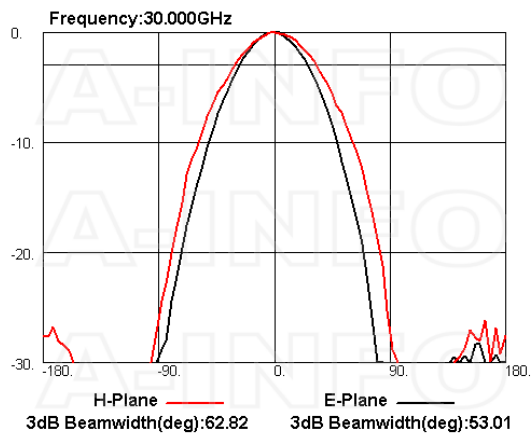
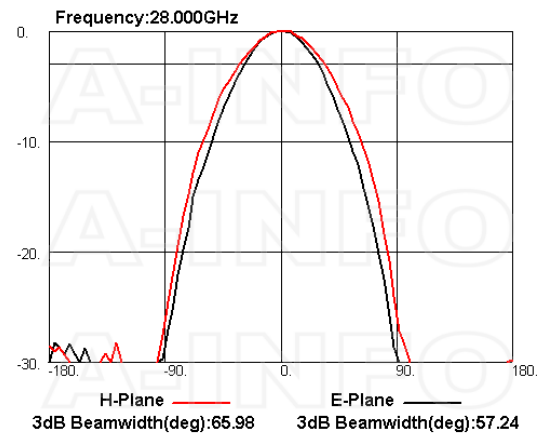
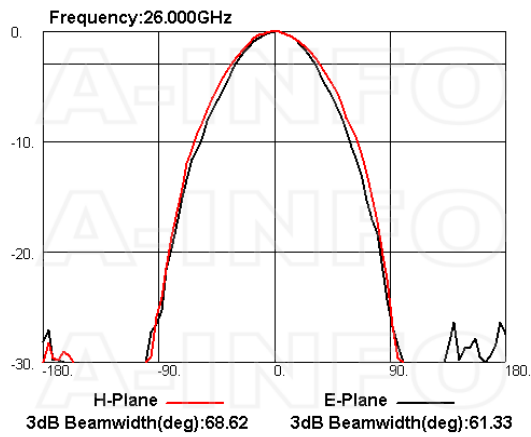

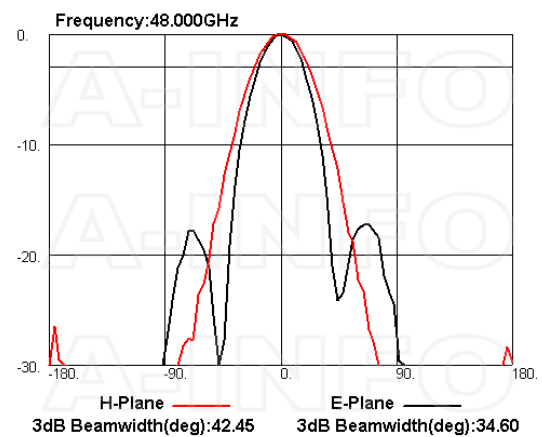
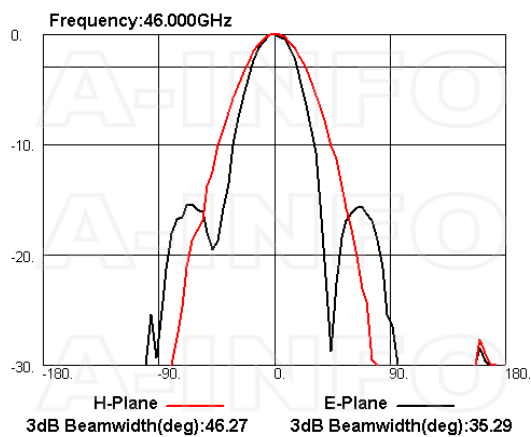
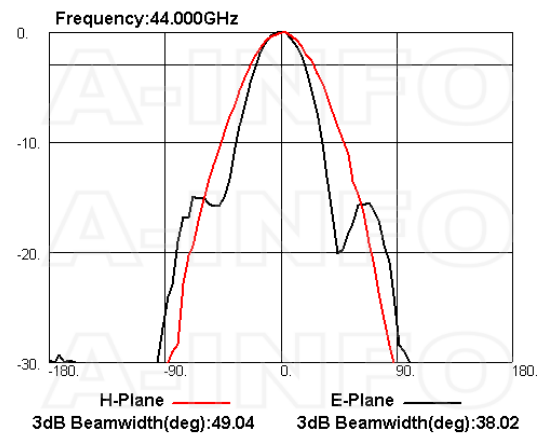
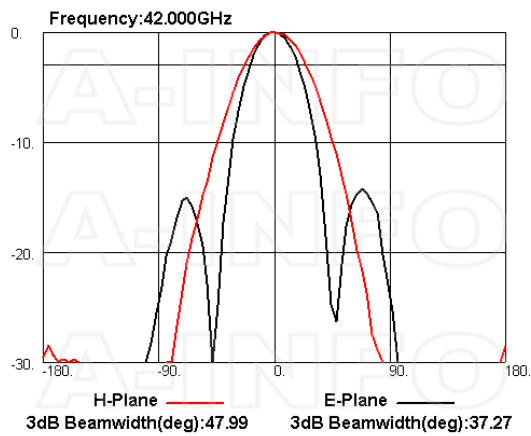
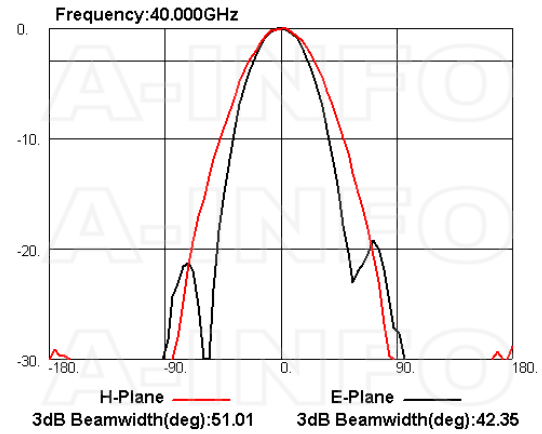
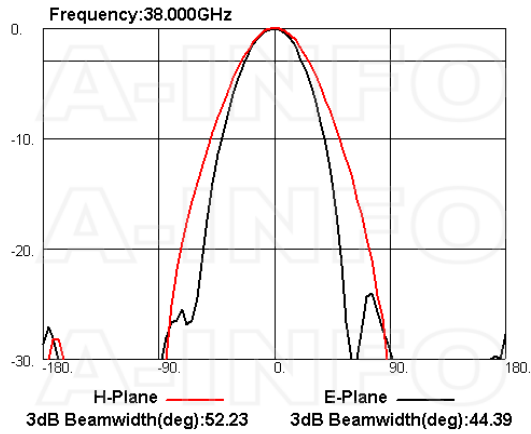

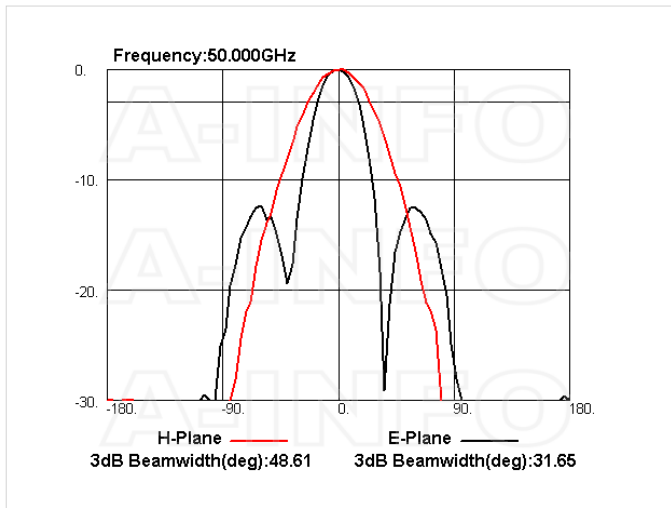

Related Products



LB-SJ-180400-L L Type Mounting Bracket



Tripod_15Kg Al Alloy Tripod



3033HL Wooden Tripod



3033QM Wooden Tripod Metalfree



Carrying Case_LB-SJ-180500L Al Alloy Carrying Case



2.4M-2.4M-B020-500 Flexible Cable Assembly 500mm DC-50GHz 2.4mm Male to 2.4mm Male



2.4M-2.4M-B020-1000 Flexible Cable Assembly 1000mm DC-50GHz 2.4mm Male to 2.4mm Male



2.4M-2.4M-B020-1500 Flexible Cable Assembly 1500mm DC-50GHz 2.4mm Male to 2.4mm Male



2.4M-2.4M-B020-2000 Flexible Cable Assembly 2000mm DC-50GHz 2.4mm Male to 2.4mm Male



2.4M-2.4M-B020-3000 Flexible Cable Assembly 3000mm DC-50GHz 2.4mm Male to 2.4mm Male



2.4M-2.4M-B020-5000 Flexible Cable Assembly 5000mm DC-50GHz 2.4mm Male to 2.4mm Male



2.4M-2.4M-B020-10000 Flexible Cable Assembly 10000mm DC-50GHz 2.4mm Male to 2.4mm Male



2.4M-2.4F-B020S-500 Flexible Cable Assembly 500mm DC-50GHz 2.4mm Male to 2.4mm Female



2.4M-2.4F-B020S-1000 Flexible Cable Assembly 1000mm DC-50GHz 2.4mm Male to 2.4mm Female



2.4M-2.4F-B020S-1500 Flexible Cable Assembly 1500mm DC-50GHz 2.4mm Male to 2.4mm Female



2.4M-2.4F-B020S-2000 Flexible Cable Assembly 2000mm DC-50GHz 2.4mm Male to 2.4mm Female



2.4M-2.4F-B020S-3000 Flexible Cable Assembly 3000mm DC-50GHz 2.4mm Male to 2.4mm Female



2.4M-2.4F-B020S-5000 Flexible Cable Assembly 5000mm DC-50GHz 2.4mm Male to 2.4mm Female



2.4M-2.4F-B020S-10000 Flexible Cable Assembly 10000mm DC-50GHz 2.4mm Male to 2.4mm Female

About this Datasheet

<ul style="list-style-type: none"> ● Product Information Product Link: https://www.ainfoinc.com/lb-sj-180500l-2-4f-broadband-dual-polarization-horn-antenna-18-50-ghz-8db-gain-2-4mm-female Data subject to change without notice. © A-INFO INC. 2024. All Rights Reserved 	<ul style="list-style-type: none"> ● Contact Us Address: 60 Tesla, Irvine, CA 92618, USA Website: www.ainfoinc.com Email: sales@ainfoinc.com 	<ul style="list-style-type: none"> ● Phone & Fax Phone: +1-949-639-9688 +1-949-639-9608 Fax: +1-949-639-9670
---	--	--